

INSTRUCTION BOOK

for

MODEL SX-28

SUPER SKYRIDER RECEIVER

FREQUENCY RANGE — .55 to 43. MEGACYCLES

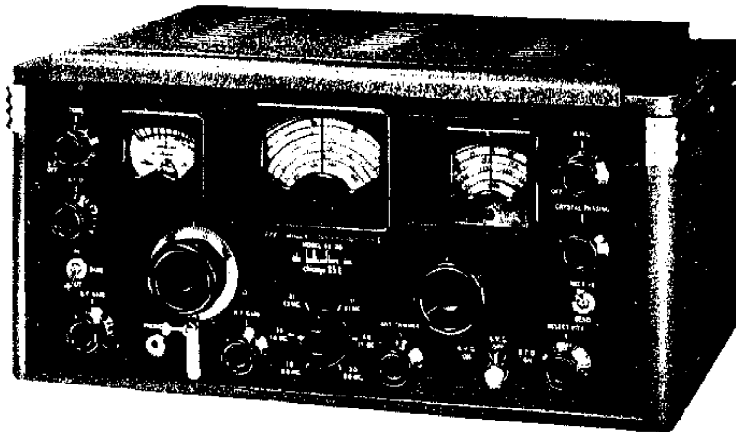

the hallicrafters *co.*

CHICAGO, ILL., U. S. A.

TABLE OF CONTENTS

<i>Subject</i>	<i>Page</i>
TITLE PAGE	1
TABLE OF CONTENTS	2
A. Installation	4
1. Speaker	4
2. Antenna	4
3. Stand-by Socket	4
4. Phono jack	4
5. DC power socket	4
6. "S" meter zero set	5
B. Operation	5
1. Bandswitch	5
2. Bandspread	5
3. Tone control	5
4. Send-Receive switch	5
5. R F. Gain control	5
6. Antenna trimmer	5
7. A. F. gain control	5
8. Selectivity control	6
9. Crystal Phasing control	6
10. Automatic noise limiter	6
11. "AVC-BFO" switch	6
12. Bass "IN-OUT" switch	7
13. Head phone jack	7
C. Summary of related circuits	7
1. The 2 stage preselector	7
2. The oscillator and converter	7
3. The I F amplifier	7
4. Variable selectivity	7
5. Crystal filter circuit	8
5a. Single signal adjustment	8
5b. Crystal	8
6. Noise limiter	9
7. AVC action	11
8. "S" or signal intensity meter	11
9. The second detector	11
10. The beat frequency oscillator	11
11. The audio amplifier	11
12. The power supply	11
13. Specifications	11
D. Receiver Alignment	12
1. I. F. Alignment	12
2. BFO adjustment	12
3. Noise limiter and AVC amplifier adjustment	12
4. R.F. and OSC. alignment	12

<i>Subject</i>	<i>Page</i>
E. Table to tube socket voltages.....	16
F. Guarantee	16
G. List of replaceable parts.....	17
H. Index to parts manufacturers.....	37
I. Drawings illustrations	
Fig. 1—IF Selectivity	6
Fig. 2—Crystal filter schematic.....	8
Fig. 3—Single signal operation.....	8
Fig. 4—Crystal selectivity	8
Fig. 5—Noise limiter schematic.....	9
Fig. 6—Noise limiter action.....	10
Fig. 7—AVC curve	10
Fig. 8—SX28 Top view	13
Fig. 9—SX28 Rear view.....	13
Fig. 10—Audio fidelity curve.....	14
Fig. 11—Audio filter curve.....	14
Fig. 12—RF and Oscillator adjustment location and alignment procedure.....	15
Fig. 13—SX28 Schematic	38

INSTRUCTION BOOK FOR MODEL SX-28 SUPER SKYRIDER

A INSTALLATION

It is recommended that, upon receipt, the carton and then the receiver be carefully examined for any damage which might have occurred in transit. Should any sign of damage be apparent immediately file claim with the carrier stating the extent of the damage.

Important: Unless otherwise marked, this receiver is to be operated from 110-125 volts of 50/60 cycle alternating current. A universal 110-220 volt model is obtainable on order. This model can be operated at either of those two voltages with 25/60 cycle current. If the voltages are higher than indicated an external stepdown transformer must be used. A switch, mounted on the top of the universal transformer case, will allow convenient 110-220 voltage change.

The standard model SX-28 receiver comes equipped with a cabinet for table mounting. The standard $8\frac{3}{4}$ " x 19" panel dimension with holes suitably spaced make it possible for the chassis to be mounted in a standard relay rack. Maximum overall chassis length is $17\frac{3}{8}$ " and depth $13\frac{1}{2}$ ". When the model SX-28 is so mounted the table cabinet is replaced with a dust cover. The maximum over-all length of the receiver will then allow it to be mounted in a rack with upright channel clearance of $17\frac{1}{2}$ ".

TERMINALS AND CONNECTIONS ON REAR OF RECEIVER

(1) SPEAKER

On the rear apron of the receiver's chassis appear two terminal strips for connecting either a 500 or 5000 ohm speaker to the receiver. Should a matching HALLI-CRAFTERS Bass-Reflex speaker be used with the receiver, it should be connected to the 5000 ohm terminals. The 500 ohm terminals can be connected to a speaker or other load of that impedance value.

(2) ANTENNA

To the terminals marked A1-A2 and G should be connected the antenna you have chosen to use with the model SX-28 receiver.

Very satisfactory results throughout the tuning range of the SX-28 will be obtained with a conventional inverted "L" Marconi type of antenna 75 to 100 feet long including lead-in. This antenna should be erected as high as possible and removed from surrounding objects. Be sure that the antenna is insulated from the ground at all points. When this type of antenna is used it is connected to terminal A-1. The Jumper between A-2 and G should remain connected.

In the event a doubler antenna is used with the model SX-28 SUPER SKYRIDER receiver, the two wires of the doubler lead-in should be connected to terminals A1 and A2. The Jumper between A2 and G can remain connected or removed, depending upon its effect on favorable reception.

A ground can be used if desired and should be connected to the G terminal. Connecting the receiver to a good ground (cold water pipe or 6 foot rod driven in moist soil) might improve reception and reduce noise. Under normal conditions no noticeable difference will exist so a ground is suggested only if it aids reception.

Should you wish to have a separate antenna for some one short wave frequency or band, a half-wave antenna cut to the proper length for the desired frequency will prove very effective. The following formula will give the length of the $\frac{1}{2}$ wavelength antenna depending on the desired frequency.

$$\text{Length in feet} = \frac{463}{\text{frequency in megacycles.}}$$

or, for example, a half wave 40 meter antenna would be $\frac{463}{7} = 66.14$ feet long.

The antenna should preferably be of solid soft drawn enameled copper wire for ease in handling. The center of the wire is cut and an insulator inserted at that point. The twisted pair, or open wire transmission line, is then soldered to each 33 foot length, after the enamel has been scraped off, directly on either side of this center insulator. The other end of the transmission line should be connected to A1 and A2 on the receiver. It should be remembered that such an antenna has directional properties broadside to its length and should be so oriented if maximum pickup from a certain direction is to be expected.

In designing transmission line systems for a more accurate match of the line to the antenna input circuit, it will be helpful to know that the approximate antenna input impedance of the receiver is 400 ohms.

(3) STAND-BY SOCKET

The Send-Receive switch on the front panel makes the receiver inoperative by removing the plate voltage from the tubes when the switch is in the SEND position. Connected in parallel with this switch is the standard 110 volt receptacle on the rear chassis edge. Should you wish to make the receiver inoperative by using a remote relay or switch, connect the contacts of the relay to a standard plug, insert it in the STAND-BY switch socket and the external relay or switch will close and open the circuit so long as the SEND-RECEIVE switch on the front panel is in the SEND position.

(4) PHONO-JACK

The Phono-Jack enables you to use the high fidelity audio amplifier of the receiver for phonograph record or transcription play-back purposes. A high impedance crystal or magnetic pick-up arm should be used for this purpose and connected to a standard headphone plug. This plug is then inserted in the PHONO-JACK when record playing is desired. The receiver is inoperative to radio signals, when the plug is in the phono-jack.

The volume of the audio amplifier is varied by rotating the AF Gain control until the proper level is obtained. Removal of the plug from the Phono-Jack once more places the RF and IF portions of the receiver in operation.

(5) DC POWER SOCKET

The DC Operation Socket can be used when it is necessary to furnish power to the receiver from a direct current source. For conventional AC operation, the shorting plug must remain in the DC Operation socket. This plug should be removed for battery or vibrapack operation.

A similar plug to the shorting plug should be wired as shown in Fig. 13 and connected to the external source of DC power. The DC operation plug is then inserted in the socket and operation from batteries or a vibrapack is secured.

270 volts of plate voltage, or B supply, at 150 milliamperes current are necessary for successful operation of the receiver, should it be operated in this manner.

(6) "S" METER ZERO SET

"S" METER CONTROL is obtained by varying the knurled knob appearing on the left hand chassis apron edge. This control enables you to properly set the "S" Meter to zero. In order to make the adjustment correctly, the RF GAIN CONTROL must be advanced clockwise as far as it will go. In addition, the switch directly below the bandspread hand-wheel must be in the AVC-ON Position. When these conditions have been complied with, remove the antenna from the Receiver and then adjust the S meter control until the S meter reads zero. Reconnecting the antenna to the receiver will then make the meter indicate the relative carrier strength of each incoming signal as various signals are tuned in.

B OPERATION

Each control of the Model SX-28 SUPER SKYRIDER receiver performs a definite function that contributes to the outstanding reception capabilities of the unit. Full appreciation of the receiver is to be expected only after you have become familiar with each of the controls and the effect their operation has on the receiver's performance.

The large calibrated main dial shows the frequencies covered throughout the 6 band, 550 kc to 43 mc frequency range of the receiver. They are as follows:

Band 1—	550	to	1,600	kilocycles
Band 2—	1.6	to	3.0	megacycles
Band 3—	3.0	to	5.8	megacycles
Band 4—	5.8	to	11.0	megacycles
Band 5—	11.0	to	21.0	megacycles
Band 6—	21.	to	43.	megacycles

- (1) The BAND SWITCH, directly below the main dial, will place the proper set of coils in the circuit to cover the desired frequency. The main dial is turned by the large handwheel which is equipped with a micrometer scale for maximum accuracy in resetting or logging purposes. Of particular interest is the locking clutch which will be found directly below the handwheel. This feature will allow you to lock the main dial after a desired signal has been tuned in. Subsequent movement of the handwheel will not detune the receiver because the control is provided with a clutch which disengages the handwheel once the dial lock has been set.

The International Shortwave broadcast bands are indicated on the main dial by heavier lines showing the frequencies on which these transmissions will be heard.

The Amateur band setting positions of the main dial are indicated by a small O appearing over the red numbers which identify each amateur band. The hairline on the main dial window should be set so that it intersects this small circle when the main dial is placed in position for the desired amateur band.

- (2) The BANDSPREAD dial is calibrated for the 10-20-40 and 80 meter amateur bands. When tuning on the 160 meter band the main dial should be used.

Note: The calibration on the main dial will be accurate

only if the bandspread condenser is set at minimum capacity which is indicated by a setting of 100 on the bandspread logging scale. It should be recognized that if the bandspread condenser is left at any other setting but 100, that small amount of bandspread condenser capacity, added to the main tuning condenser capacity, would throw off the main tuning dial calibration because the receiver is calibrated with the Bandspread condenser set at minimum capacity. The portions of the amateur bands on which type A3, or telephone, transmissions will be heard are underscored with another dark line.

The numbered outer edge of the bandspread dial will prove to be of great help for logging or pre-setting purposes when the bandspread tuning control is used for easier tuning on frequencies other than those covered by the amateur bands.

When "bandspreading" any frequency throughout the tuning range of the receiver remember the main dial must then be set to a slightly higher frequency than the desired signal. The difference depends on the amount of bandspread condenser capacity used and the frequency of the received signal.

When switching from one range to another, an indicator moves vertically behind both the main and bandspread dials. Tuning fatigue is thereby greatly minimized by focusing attention on only the frequencies covered by that particular setting of the bandswitch.

The translucent, indirectly lighted dials are easily read and so arranged that parallax is reduced to an absolute minimum.

To operate the receiver adjust the following controls in the order in which they are mentioned:

- (3) The TONE CONTROL turns the receiver on and off and in addition emphasizes either the base or treble frequencies to the extent required by various receiving conditions. The effect the Tone Control has on the fidelity of reproduction is shown in Fig. 10.

- (4) Place the SEND-RECEIVE switch in the RECEIVE position—have the ANL control off (turned to the left until the switch operates).

Place the bandswitch in position .55 to 1.65 mc, which will then enable you to tune in stations on the standard Broadcast Band.

- (5) Rotate the RF GAIN control to the right until #9 on the skirt of the control appears under the panel marker. (The RF Gain must be full ON as above indicated before the S meter will indicate correctly.) So that the S meter will be properly connected in the circuit, the AVC-BFO switch appearing to the lower right of the bandspread handwheel, must be in the AVC ON position.

- (6) Note: The Antenna Trimmer control is operated on all Bands. Proper adjustment of this control is indicated by the maximum signal.

- (7) After complying with the above conditions, the AF GAIN control should be advanced to the right until the desired volume is obtained. Tuning the receiver by operating the main dial handwheel will now allow you to pick up stations throughout the .55 to 1.65 mc tuning range of the Broadcast band. Maximum deflection of the S Meter will indicate when each station is accurately tuned in.

When covering the short-wave or higher frequency bands the above procedure should be followed—except that greater care should be used because it is so easy to completely pass over a station.

The other controls on the model SX28 SUPER SKYRIDER receiver will enable you to obtain the best results

from the receiver once you have become used to their effects on the reception of various types of signals.

(8) The SELECTIVITY control acts as a shutter or gate and varies the width of the path on which signals reach the second detector of the receiver. Six different selectivity steps are provided so that you can successfully cope with different degrees of interference. Reference to Fig. 1 and Fig. 4 will show, graphically, how the control trims the width of the signal so that what interference might be present in the signal's skirts or sidebands is effectively clipped off. Should an interfering signal lap over into the desired signal, adjustment of the SELECTIVITY control, will reduce that interference.

FIG. 1—I. F. SELECTIVITY

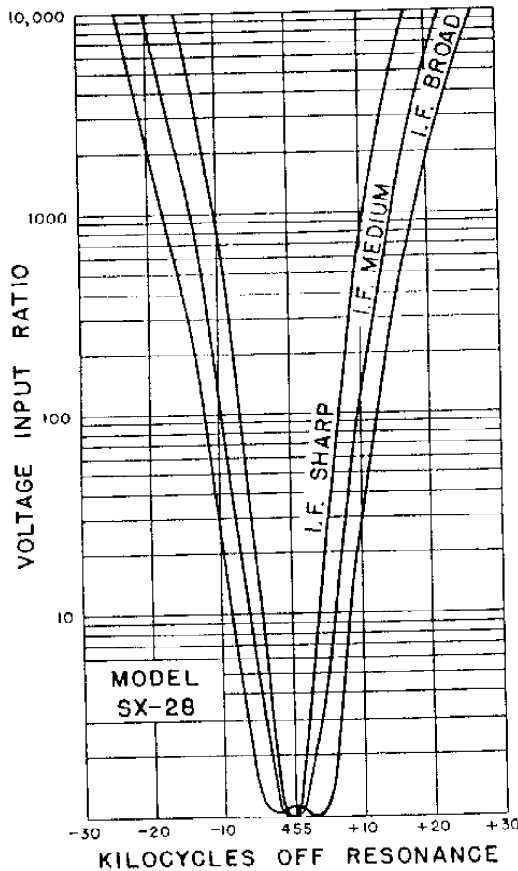

Once more refer to Fig. 1 and Fig. 4 and recognize the fact that with the control set in the BROAD IF position, the signal proper and all its parts, which are combined in the side bands, or skirts, will be passed to the 2nd detector, audio amplifier, and then Speaker. As the selectivity of the receiver is increased from BROAD-IF to XTALSHARP, the gate, or admittance path, is so narrowed that only the main portion of the signal is allowed to pass through. This fact and its effect on the quality of reproduction is readily appreciated by listening to a signal and noting the reduction in higher frequency response in the more selective settings of the switch. (See Fig. 10 and Fig. 11)

At this point, it is suggested that the CRYSTAL SHARP setting be used only in cases of extreme interference—the receiver must then be tuned exactly to the signal. Only then will the signal be intelligible because you have clipped off its sidebands in which the sibilants and overtones are embodied.

The CRYSTAL SHARP position of the selectivity switch is to be used principally for the reception of code, or CW, signals. By proper associated operation of the CRYSTAL PHASING control true single signal operation and the maximum in selectivity can be obtained (crystal circuit discussed in detail in the summary of related circuits). See Fig. 3.

(9) CRYSTAL PHASING CONTROL

The Phasing Control is in the circuit on three positions of the selectivity control namely—XTAL Sharp, XTAL Medium and XTAL Broad.

The control is used to remove heterodyne interference as well as to minimize other forms of interference having a predominance of high frequency components—such as static and interference from electrically operated devices.

(10) The A.N.L., or *Automatic Noise Limiter*, materially contributes to the satisfactory operation of the receiver by limiting objectionable interference caused by ignition systems or other man made causes of electrical disturbances. With the A.N.L. control retarded to the left as far as it will go, or until the A.N.L. switch is heard to operate the noise limiter circuit is not functioning. Turning the control to the right closes the switch which is mounted on the control. The noise limiter is now operating. Progressively turning the control clockwise varies the threshold at which the noise limiter starts to take hold. The setting at which the control will be left depends entirely on the type and amount of interference present as well as the signal strength. The noise limiter should be judiciously adjusted because through its operation the desired signal can even be eliminated or badly distorted which destroys its usefulness. Only after you have become familiar with the operation of this control by actual practice can you determine how far it should be advanced before the best compromise between noise and signal is obtained. (See Fig. 6.)

(11) The AVC-BFO OFF-ON switch performs a dual function. The AVC circuit should be operating for the reception of telephone, or modulated, signals in order to reduce fading to a minimum. As previously mentioned, the functioning of the S Meter is dependent upon AVC action so the switch must be in the AVC ON position when the S meter is used to measure relative carrier intensity.

Inasmuch as the AVC circuit levels all signals to a predetermined value (See Fig. 7) no one signal can overload the receiver and cause distortion. At times, in searching for distant or weak signals, it might be desirable to use the full sensitivity of the Model SX-28. In that case place the AVC switch in the AVC OFF position. Remember that with the receiver operating with no AVC action, strong signals will overload the input circuit with resultant distortion. Under such a condition of operation the sensitivity of the set must be then controlled, manually, by properly retarding the RF Gain control until you have reached the point below which overloading takes place.

The other function of this switch is to turn on the Beat Frequency oscillator. When receiving code signals, a beat note is absolutely essential. With the BFO switch in the ON position, each signal tuned in will be accompanied with a beat note or whistle. For proper adjust-

ment of the BFO control which appears directly under the TONE CONTROL the following procedure is suggested. Set the BFO control to zero, now tune in a signal either voice or code. If a code signal is received, only the carrier or thump of the signal will be audible because no beat note is present. Be sure that you have the signal accurately resonated. Now, without rerunning the receiver, rotate the BFO control until a beat note of the desired pitch is obtained. You now have introduced a beat note which differs from the IF frequency of the receiver, namely 455 kc, by the frequency of the audible signal. Variation of the BFO control will allow you to change the pitch, or frequency, of the oscillator which will prove to be of help under various conditions of interference.

- (12) Directly under the BFO control will be seen the BASS IN-OUT Switch. With this switch in the BASS IN position you will have normal audio fidelity. Placing the switch in the BASS OUT position, the audio filter CH₂ is inserted. The effect of this filter on the band of frequencies passed is shown Fig. 11. This filter will contribute greatly to the intelligibility of the received signal when the receiver is operated in the advanced positions of selectivity.
- (13) The Head Phone Jack is connected to a tap on the output transformer. The signal in the headphones is of the proper volume for satisfactory communications reception. Since no direct current is present in the headphone circuit crystal type phones can be used.

C SUMMARY OF RELATED CIRCUITS

(1) THE 2-STAGE PRESELECTOR

The RF AMPLIFIER, or pre-selector, of the Model SX-28 SUPER SKYRIDER has 1-6AB7, 1-6SK7 tubes in cascade on Bands 3, 4, 5, and 6. On Bands 1 and 2 more than one stage is unnecessary to obtain the required image ratio and reduction of spurious interference. With two RF stages using three pre-selection circuits, the band width would be narrowed to such an extent that even expanding the IF Amplifier to its utmost would still not provide high-fidelity reception. The modern communications receiver requires two stages of preselection on the higher frequencies to accomplish only one primary object—satisfactory image rejection.

The Model SX-28 has an image ratio of 20 to 1 at 28 mc—350 to 1 at 14 mc and a proportionately increasing ratio as the frequency is lowered. While the two RF stages are principally needed to obtain such image ratios they also perform two other useful functions—more favorable signal to noise ratio and slightly increased selectivity.

Examining the coil assembly will immediately show how rigidly it is constructed and what care has been taken to completely shield each section from the other. The manner in which the RF and antenna coils are tuned on bands 3, 4, 5, and 6 will be interesting. Rather than push turns to compensate for variations in inductance, each coil is permeability tuned. This results in exact adjustment of inductance with improved tracking and gain as the result. On Bands 1 and 2 the inductance of the antenna coils is sufficiently large so that lead length differences do not cause any noticeable inductance change.

(2) THE OSCILLATOR AND CONVERTER

A separate 6SA7 tube is used as the High Frequency Oscillator in the Model SX-28 SUPER SKYRIDER. This tube proves desirable in this function because of its very high value of transconductance which enables the oscillator to operate with very little coupling to the coil. This feature reduces the unfavorable effects of tube variations and voltage fluctuations on the tuned circuit. The HF Oscillator is coupled to the 6SA7 converter tube at the Cathode Tap—a point where variations of operating parameters of the converter tube will least affect the 6SA7 Oscillator. A 6SA7 tube is used in the Mixer Circuit because tests indicated that changes in operating voltages caused less reflection in the injector grid loading than would occur in most converter tubes. Another feature in favor of the 6SA7 tube is that a negative loading is

applied to the tuned circuit feeding its control grid. This characteristic improves the gain and selectivity of the tuned circuit which in turn improves the image and signal to noise ratio.

(3) THE IF AMPLIFIER

The IF Amplifier of the Model SX-28 was designed with a view towards permanency of adjustment under conditions of extreme changes in temperature and humidity as well as unusual mechanical vibration.

The first two IF Transformers are permeability tuned. In comparing this type of transformer with one having compression mica tuning condensers, it must be remembered that it takes many more turns of the adjusting screw to cause the equivalent change in tuning of the permeability tuned type. Hence a slight change in the position of the screw will have negligible effect upon the tuning. The adjusting screw is under spring tension thereby making it impossible to turn under vibration.

The diode transformer is air-tuned with two variable condensers each with a lump capacity of 50 mmf and variable of 50 mmf. These air trimmers are also under spring tension so that they can withstand considerable vibration. Being of the air tuned type, their capacity change is negligible with wide changes in humidity. Reference to the Schematic will show that the IF transformers are expanded in two steps—thereby enabling medium or full reproduction of the higher frequencies to be obtained.

(4) VARIABLE SELECTIVITY

Six ranges of selectivity are provided in the model SX-28 receiver. They are:

- 1 - Broad IF—(for high fidelity reception)
- 2 - Medium IF—(more selectivity—less highs)
- 3 - Sharp IF—(reduces annoying interference—far less highs)
- 4 - Crystal Broad—(Similar to Sharp IF but cleaner cutting of side bands)
- 5 - Crystal Medium—(next selectivity step to #4—greatly increased sideband cutting—more pronounced crystal "Slot" for interference—very little highs present)
- 6 - Crystal Sharp—(position of extreme selectivity—practically no sideband content—very pronounced crystal "slot")

The graphic effects of the different steps of selectivity on a signal are shown in Fig. 1 and Fig. 4.

FIG. 2—CRYSTAL FILTER SCHEMATIC

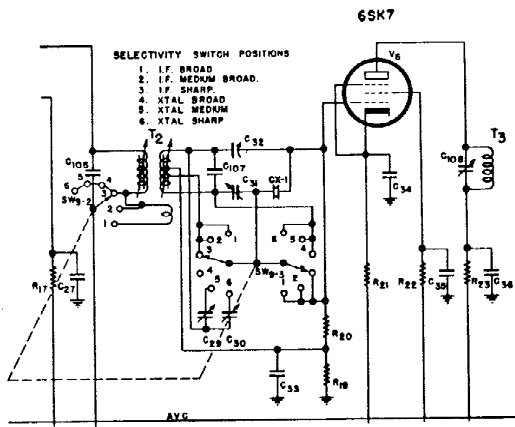

(5) CRYSTAL FILTER CIRCUIT

In positions 1, 2, 3 the crystal is short circuited. In position 4 the short across the crystal is opened and the iron core in the secondary of the transformer is adjusted for Broad Crystal Action and at this point is accurately tuned to the crystal frequency. Due to the close coupling of the secondary to the crystal, the sharply rising resonance curve of the crystal causes, in contrast, a sharply falling resonance curve in the secondary. The combined action of these two characteristics results in a relatively broad resonance curve for the CRYSTAL BROAD selectivity setting. In the MEDIUM CRYSTAL No. 5 position, C₃₀ is adjusted for selectivity midway between the BROAD and CRYSTAL SHARP settings. (See Fig. 2 and Fig. 4)

In position 6, or CRYSTAL SHARP, the trimmer C₃₀ is adjusted for the Sharpest crystal action. Under this condition, the Secondary is slightly detuned from the resonant crystal frequency sufficiently so that its resonance curve is not greatly affected by the crystal but still coupled tightly enough so that it can transfer energy to the crystal circuit. When this point is reached it is indicated by a rise in the output. Two such points of increased output will normally occur—one for each adjustment of the secondary on either side of the resonant frequency of the crystal.

(5a)

SINGLE SIGNAL ADJUSTMENT

It is extremely simple to attain single signal reception with the SX-28. First, turn on the BFO to the desired Beat Note and turn the selectivity switch to the XTAL SHARP position. Pick a good solid CW signal, preferably a commercial station because a commercial is likely to stay on long enough for you to complete the phasing adjustment for single signal reception.

You will find on tuning across this signal that it has two amplitudes. Tune first to the weaker of these two amplitudes. Now, turn the PHASING control until this weaker of the two amplitudes is reduced to a minimum. (If the weaker amplitude appears on the right the above procedure still holds.) Then tune to stronger of the two amplitudes and adjust the BFO control to a tone most pleasing to you. This adjustment for single signal selectivity will hold with no further adjustment unless you change the phasing control. (See Fig. 3)

FIG. 3—SINGLE SIGNAL OPERATION

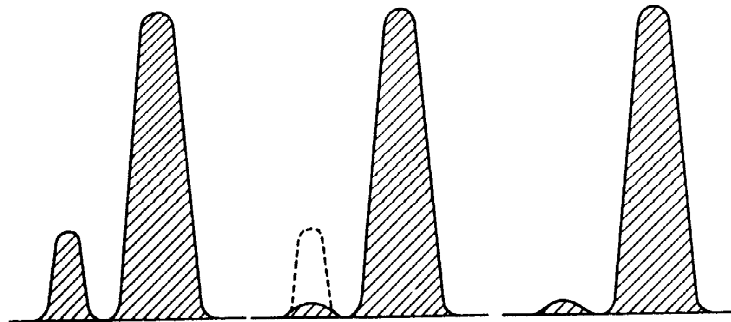

With Selective Switch in XTAL Sharp position identify the weaker amplitude—Tune Receiver to the weaker.

Adjust phasing control carefully until this weaker amplitude is reduced to a minimum.

Retune Receiver to the stronger amplitude and then adjust pitch control until you get note most pleasing to copy.

FIG. 4—CRYSTAL SELECTIVITY

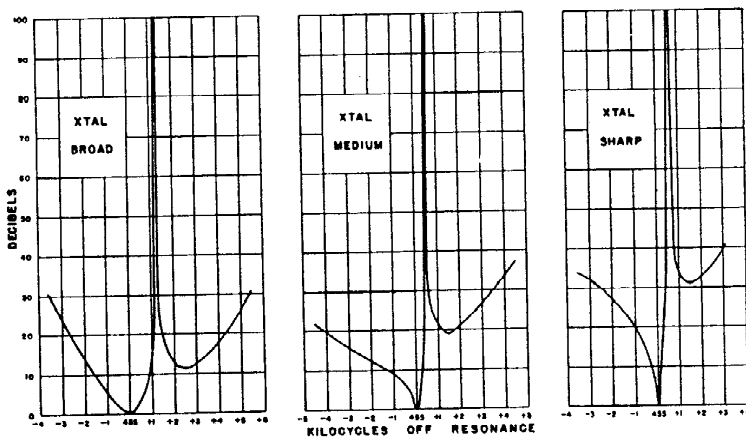

(5b)

CRYSTAL

The CRYSTAL FILTER and holder are wired directly into the receiver and do not plug in as heretofore. In this manner exceptional crystal filter action is obtained because of the elimination of the capacity and losses of a socket. So mounting the crystal prevents possible change in polarity which would occur if the crystal were improperly inserted in the circuit. The size of the crystal has been carefully determined to allow the BROAD CRYSTAL position to tune as broadly as possible. The capacity of the crystal holder has been reduced to a minimum through the use of a specially designed polystyrene holder.

(6) **NOISE LIMITER**

The principle of operation of the limiter is very similar to that of the Lamb limiter which has been described in detail in past issue of QST. The carrier of the received signal is first converted over to the intermediate frequency and then fed into the 6L7 amplifier and 6B8 AVC amplifier and 6AB7 noise amplifier. A broadly tuned IF transformer is used in the plate of the 6B8 with its primary and secondary closely coupled. The secondary feeds into the 6B8 diode where rectification of the carrier furnishes AVC voltage for the RF and mixer tube as well as for the 6AB7 noise amplifier. A broadly tuned IF transformer is used in the plate of the 6AB7, the secondary feeding into the 6H6 noise rectifier. A 455 kc wave trap (CH4 and C55) is used which allows the passage of the higher audio frequencies without attenuation. In the form of further explanation of our approach toward noise elimination, it must be remembered that noise in

general is composed of a random mixture of high and low frequencies. Of this mixture the predominating higher frequencies are the most objectionable. It is to our advantage to retain the high frequency components. Thus, these transients will be allowed to rise to a point far above the carrier level with the result that they will be applied to the injector grid of the 6L7 tube without being reduced in value. Transients, such as ignition interference having a steep wave front, consist largely of high frequency components. The voltage applied to the grid of the 6L7 tube has a negative polarity because of the 6H6 noise rectifier. By varying the ANL control, we raise or lower the negative voltage applied to the 6L7 tube until it is barely sufficient to overcome the noise impulses applied to the grid of this tube without allowing the modulation peaks of the carrier to become badly distorted.

FIG. 5—NOISE LIMITER SCHEMATIC

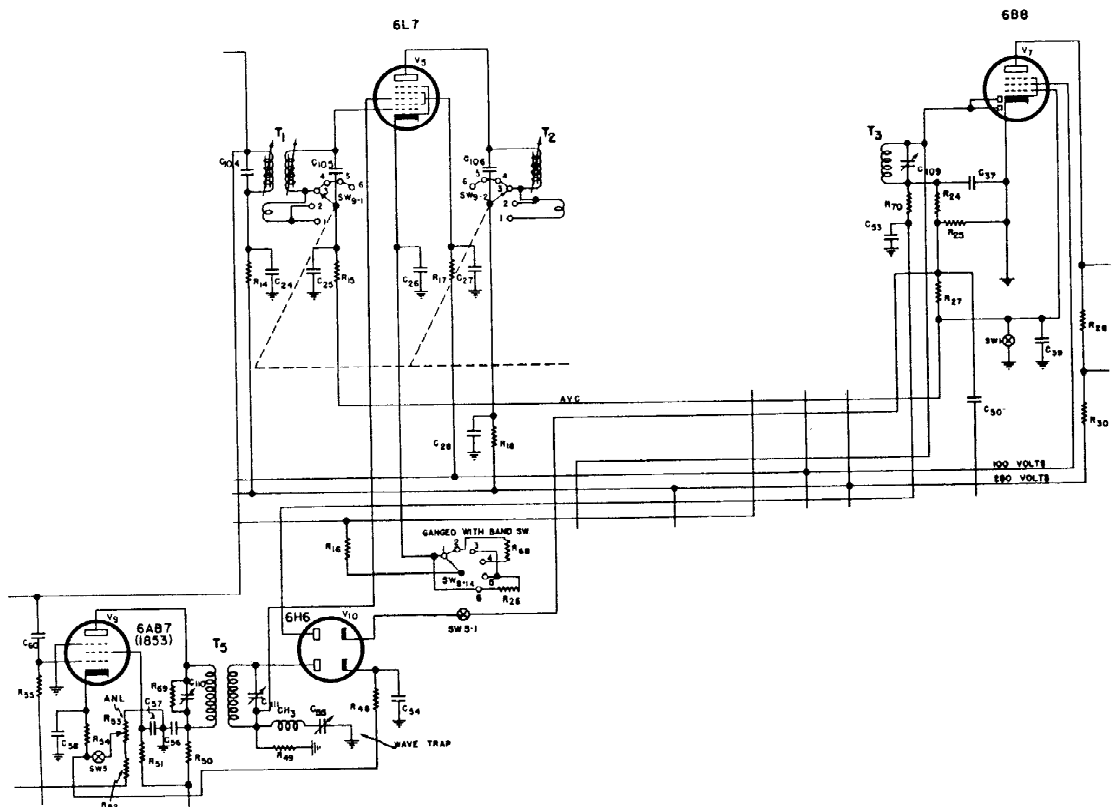
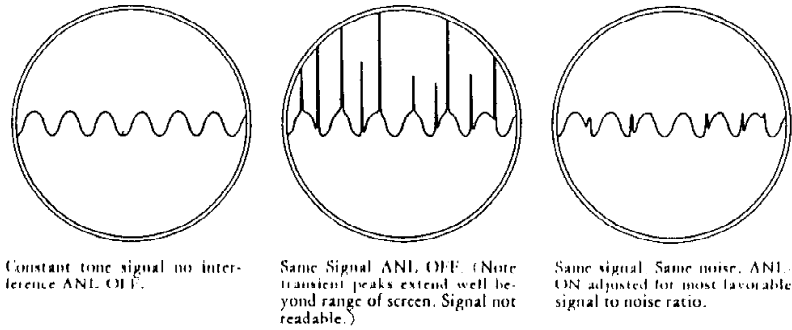

FIG. 6—NOISE LIMITER ACTION



If the noise limiter adjustment permits too great a value of transient voltage to be applied to the 6L7 injector grid, detection will take place and rectified components of this modulated carrier will appear in the 6L7 plate circuit. This effect will appear as distortion in the output of the receiver. If, on the other hand, not enough

noise voltage is applied, then the momentary decrease in sensitivity will not be great enough to stop the noise from getting through and some of it will appear in the plate circuit of the 6L7 tube and consequently in the output of the receiver. As a result the noise limiter must be carefully adjusted to the particular carrier and noise level being received. (See Fig. 6)

FIG. 7—A.V.C. CURVE—AT 3 MC.

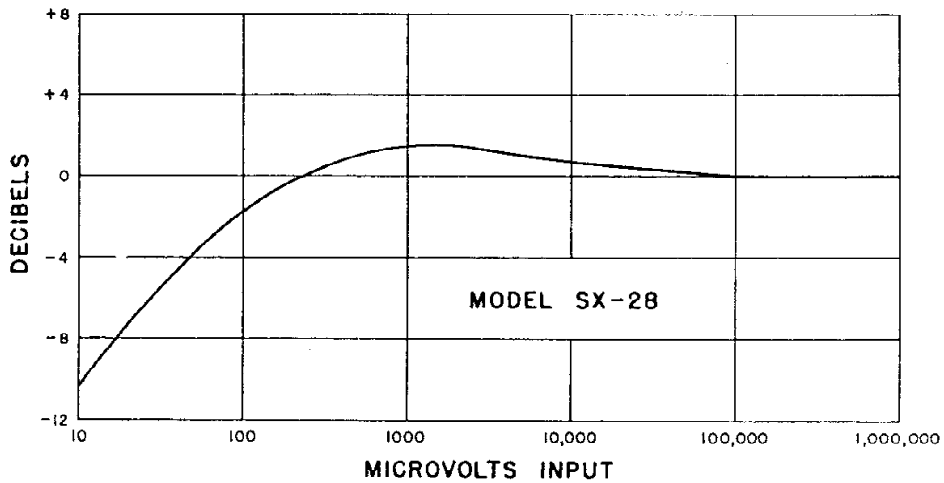

(7) **AVC ACTION**

A double AVC system is used. The RF and mixer tubes are operated by the broadly tuned carrier coming through only three tuned IF circuits. The final signal however passes through six-tuned IF circuits. As a result, when the signal is slightly detuned, the receiver output has dropped considerably while the AVC action has dropped but very little. This results in a reduction of between-station noise and a more sharply defined aural tuning action.

(8) **"S" OR SIGNAL INTENSITY METER**

The approximate DB per S unit equivalent is 6 DB's. As is known, a DB, or decibel, is a unit of change in signal level and is defined as being the least detectable change the average ear can appreciate when listening to a single pitched tone. 3DB is the least change the ear detects when listening to sounds varying in both amplitude and pitch. By comparison, a variation of one S unit on the meter will indicate a change of two detectable steps in signal level. Quantitatively, a DB gain or loss is equal to $20 \log_{10} \left(\frac{E_1}{E_2} \right)$ where E_1 = input voltage and E_2 = output voltage.

(9) **THE SECOND DETECTOR**

As will be noted, a diode type of second detector is used in the Model SX-28. Its choice was prompted by the fact that such a detector is capable of handling large percentages of modulation with very little distortion. This is due to the output of the diode being easily filtered (IF Removed). In addition, the rectified output contains a DC component which can be used for AVC purposes.

(10) **THE BEAT FREQUENCY OSCILLATOR**

The BFO is turned on with the switch below the band-spread handwheel and adjusted by the skirted knob directly below the tone control. The BFO circuit, as will be seen by referring to Fig. 13, is the well known Hartley oscillator. It will be noticed that a plate dropping resistor is used to compensate for plate voltage variations. An increase in receiver voltage causes an increase in the plate current of the oscillator. This increase in turn causes the voltage drop across the resistor to increase, thus maintaining a more constant voltage at the plate of the beat oscillator tube. A favorable ratio of capacity to inductance is used. The fixed tank capacity has been artificially aged by alternately exposing it to very high and then low temperatures. In this manner any residual strains of the component parts are removed and the capacity of the condenser remains constant. The BFO coil is permeability tuned which further removes the possibility of drift which would occur should a compression variable be used to resonate the circuit.

Proper location of the Beat Oscillator tube and its associated components plus excellent shielding and mechanical rigidity do much to keep stray fields from being established. Little BFO leakage is to be expected in the Model SX-28 so "sweeters" or BFO harmonics will not prove to be bothersome.

(11) **THE AUDIO AMPLIFIER**

The second or output stage of the audio amplifier in the Model SX-28 receiver uses two 6V6GT tubes connected in push-pull. These tubes are driven by the 6SC7 double triode. One of the triode sections of the 6SC7 tube is used as the inverter to the 6V6GT tubes. A portion of the signal from the plate circuit of the first 6SC7

triode is fed to the grid of the other 6SC7 triode section, thereby giving two output voltages in opposite phase suitable for exciting the push-pull 6V6GT output amplifier.

(12) **THE POWER SUPPLY**

The power supply in the Model SX-28 is quite normal except that it supplies voltage for the 6V6GT output tubes directly from the rectifier or before the filter system. Voltage fluctuations in the receiver are greatly reduced—increasing the audio output of the receiver and stabilizing the operation of all circuits.

The filter circuit consisting of a total of 60 mfd's of capacity plus an additional filter in the 6SC7 plate supply and a 12 henry choke keep the hum level of the receiver in excess of 60 DB below maximum output. The power transformer is built to withstand continuous operation at 250 degrees F but has been designed to run at approximately 160 degrees F under normal conditions.

(13) **SPECIFICATIONS**

Tubes:

- 1- 6AB7 1st RF Amplifier
- 1-6SK7 2nd RF Amplifier
- 1 6SA7 Mixer
- 1 6SA7 HF Oscillator
- 1 6L7 1st IF Amplifier Noise Limiter
- 1- 6SK7 2nd IF Amplifier
- 1- 6B8 2nd Detector and S meter tube
- 1--6B8 AVC Amplifier
- 1--6AB7 Noise Amplifier
- 1--6H6 Noise Rectifier
- 1-6J5 Beat Oscillator
- 1 6SC7 1st Audio Amplifier
- 2--6V6GT Push-Pull Output Amplifiers
- 1--5Z3 Rectifier

Power Consumption—at 117 volts -60 cycles -138 watts
Power Consumption--DC operation--18 amp. at 6 volts or 108 watts

Power Output -8 watts undistorted

Sensitivity--(for 500 milliwatts output) varies between the limits of 6 to 20 microvolts over the entire frequency range of the receiver.

	2 x	1000 x
Selectivity--IF broad (high fidelity)	12 kc	36 kc
IF Sharp	4.1 kc	22 kc

Frequency Range RF--Note: These are the actual frequencies covered corresponding to nominal figures indicated on the front panel.

- 550 to 1,620 kilocycles
- 1.5 to 3.1 megacycles
- 2.9 to 5.9 megacycles
- 5.75 to 11.5 megacycles
- 10.3 to 21.5 megacycles
- 20.4 to 43 megacycles

Frequency response AF (audio filter out--broad IF--tone control high)-70 to 3000 cycles \pm 2 1/2 DB

Speaker Output Impedances--5000 and 500 ohms

Intermediate Frequency--455 kc

Table cabinet dimensions--20 1/2" long x 10" high x 14 3/4" deep

Relay Rack dust cover dimensions--14 3/4" deep x 17 3/4" long x 8 3/4" high

Panel dimensions--19" x 8 3/4"

Chassis dimensions--17 3/8" x 13 3/4"

Weight--(unpacked) -75 lbs. packed 87 lbs.

RECEIVER ALIGNMENT

Equipment Needed for Aligning:

1—An all wave signal generator which will provide an accurately calibrated signal at the test frequencies indicated.

2—Output indicating meter connected to 5000 ohm output terminals.

3—Non-metallic screw driver.

4—Dummy antenna of 200 mmf and also 400 ohm carbon resistor.

Setting of controls prior to alignment—IF and RF.

Tone control at maximum high frequency position (#9)—BFO at 0—Bass switch at Bass IN—AF Gain at #9—RF Gain at #9—Band switch—IF alignment position .55 to 1.6 band—RF alignment depending on band aligned.

Selectivity control at sharp IF—Send-Receive switch in Receive—Crystal phasing at #3 on left side—ANL OFF at 0—AVC OFF.

Important: Have bandspread control so logging scale reads 100.

Antenna trimmer adjusted for Maximum gain at each RF alignment point on all bands.

- (1) **455 KC—IF Alignment:** Tune main dial to 1400 kc on .55 to 1.6 mc band. Connect the hot lead from the signal generator to 6SA7 mixer terminal #8—Ground to chassis. Roughly adjust the aligning screws of T1, the lower screw of which is accessible through hole in right mounting bracket, for maximum gain. Now adjust lower screw on T2 (do not adjust upper screw). Also adjust C31 and the air trimmer condensers at the top of T3 for maximum gain. (See Fig. 8 for location of IF adjustments)

Switch to Crystal Broad Position—Turn on BFO and adjust to a tone of about 1000 cycles. Vary the frequency of the signal generator while adjusting the top screw on T2 until the output goes through a maximum, dips down and starts going up again. Adjust the phasing control for maximum selectivity and then back off the top screw on T2 until the output reaches a minimum value between the two maximum values first noted. The frequency of the signal generator should be varied over a small range while adjusting the top screw of T2. A swishing note, in contrast to the usual sharp crystal tone will be ap-

parent when the correct adjustment has been reached.

Switch to "Xtal Sharp" and adjust C₃₀ for maximum output while varying signal generator frequency. Two points of maximum output will be noted corresponding to two adjustments of C₃₀. Either one of these points may be used at which to leave C₃₀. a sharply peaked tone will result at the correct adjustment.

Switch to "Xtal Medium" and adjust C₂₉ till the output is midway between the outputs reached while aligning the "Xtal Sharp" and "Xtal Broad" positions. The apparent sharpness of tone should be midway between the "Sharp" and "Broad" positions.

Switch again to "Xtal Sharp" and set the signal generator to exact crystal frequency. Set BFO front panel control to a tone of approximately 1000 cycles. Switch again to "Sharp IF" and carefully realign the IF transformers as earlier described in the first paragraph of these instructions.

- (2) **BFO Adjustment:** Set front panel control to zero—BFO switch ON—Signal Generator tuned to crystal frequency—selectivity switch in IF Sharp position—now, adjust screw on top of T4, after loosening lock nut, to zero best. (See Fig. 8)
- (3) **Noise Limiter and AVC Amplifier Adjustment:** Have the controls set as before except that the AVC switch is now in the ON position. Connect a high resistance type voltmeter across R49 which is connected between terminal #5 of the 6L7 tube and chassis. Connect a 50,000 ohm resistor across primary of T5 (Red and Blue leads). Set generator at 455 kc as for IF alignment. Connect generator to grid of 6AB7 tube (pin #4). Rotate ANL control all the way to the right, or position #9. Adjust screws on top of T5 for maximum indication on DC meter connected across R47. Reconnect generator, as for IF alignment, to mixer grid of 6SA7 tube. Remove 50,000 ohm resistor which was inserted across primary of T5 during alignment. Remove grid clip off top of 6L7 tube. With generator set at 455 kc and ANL control at extreme right adjust wave trap trimmer C55 for minimum signal as indicated on output meter. (See Fig. 8 and Fig. 12 for location of adjustments).
- With generator connected to 6SA7 mixer grid as above, replace 6L7 grid and turn ANL control to extreme left until switch clicks. Connect high resistance DC meter across 6B8 diode filter condenser C64. Adjust screw on top of T6 for maximum indication on DC meter across C64.
- (4) For RF and oscillator adjustment location and alignment procedure see Fig. 12.

FIG. 8—SX28—TOP VIEW

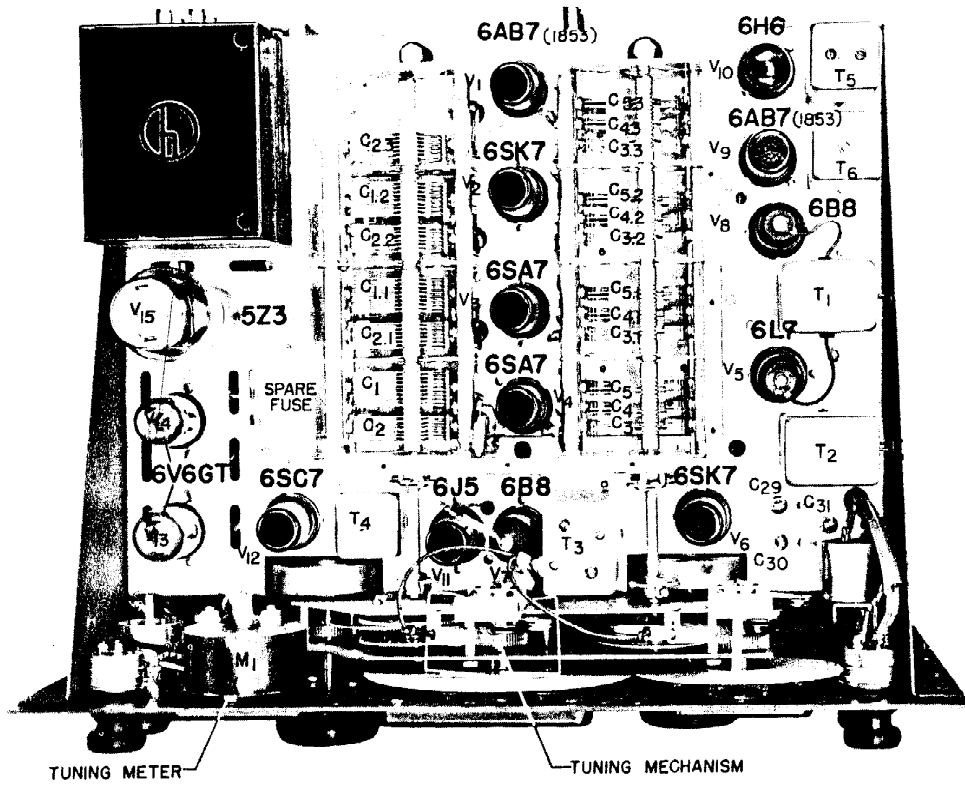

FIG. 9—SX28—REAR VIEW

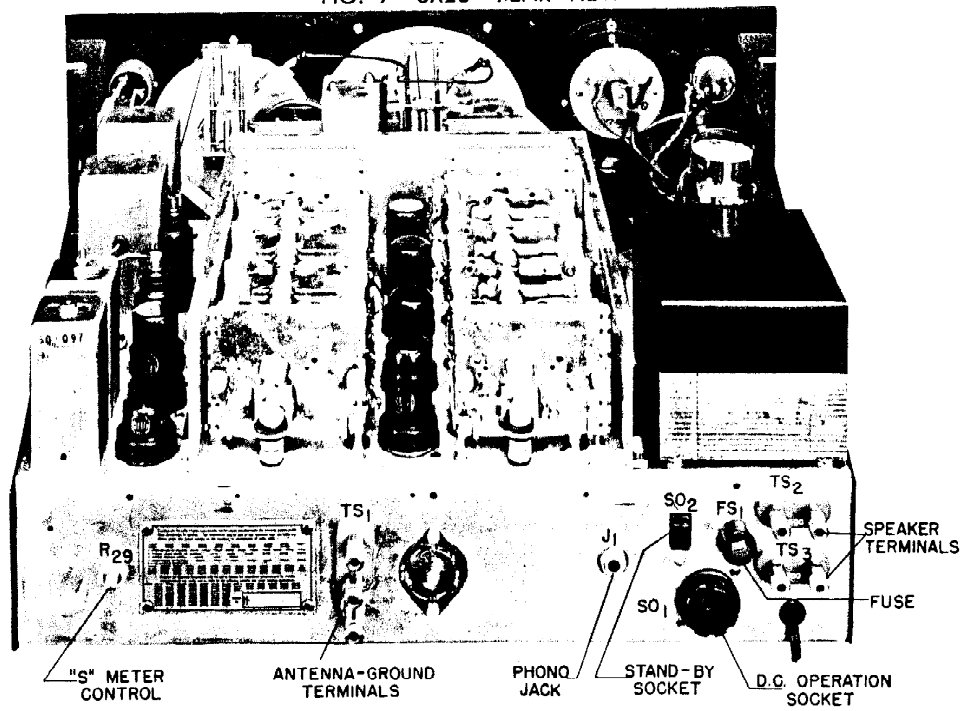

FIG. 10—AUDIO FIDELITY CURVE

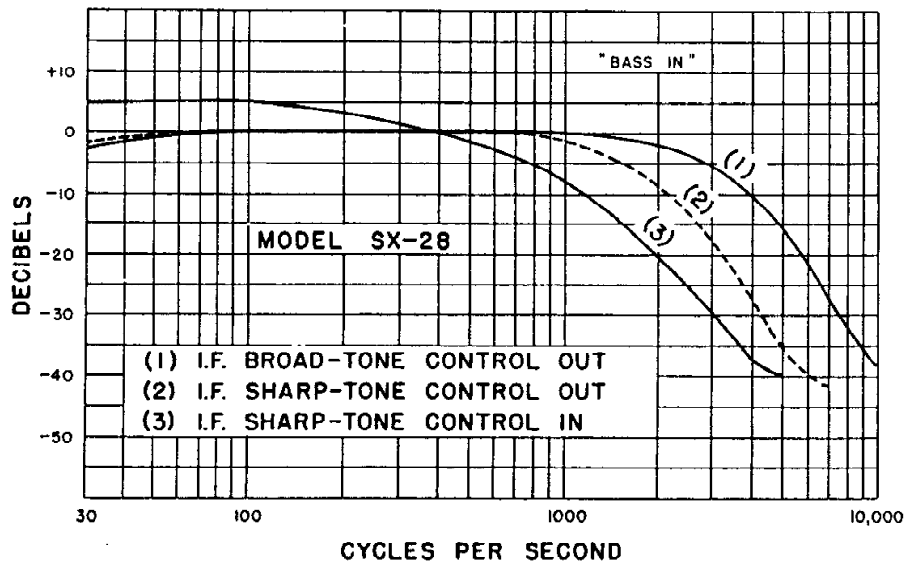

FIG. 11—AUDIO FILTER CURVE

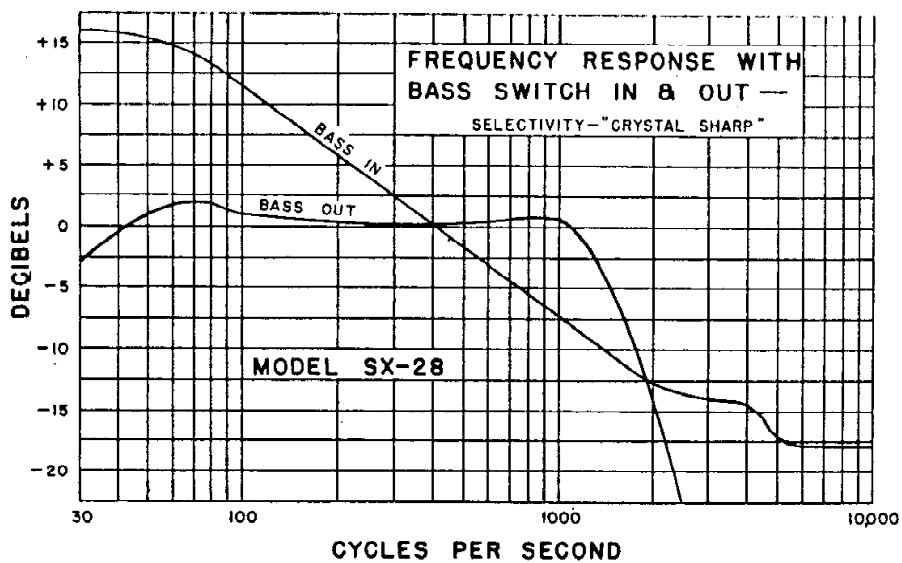
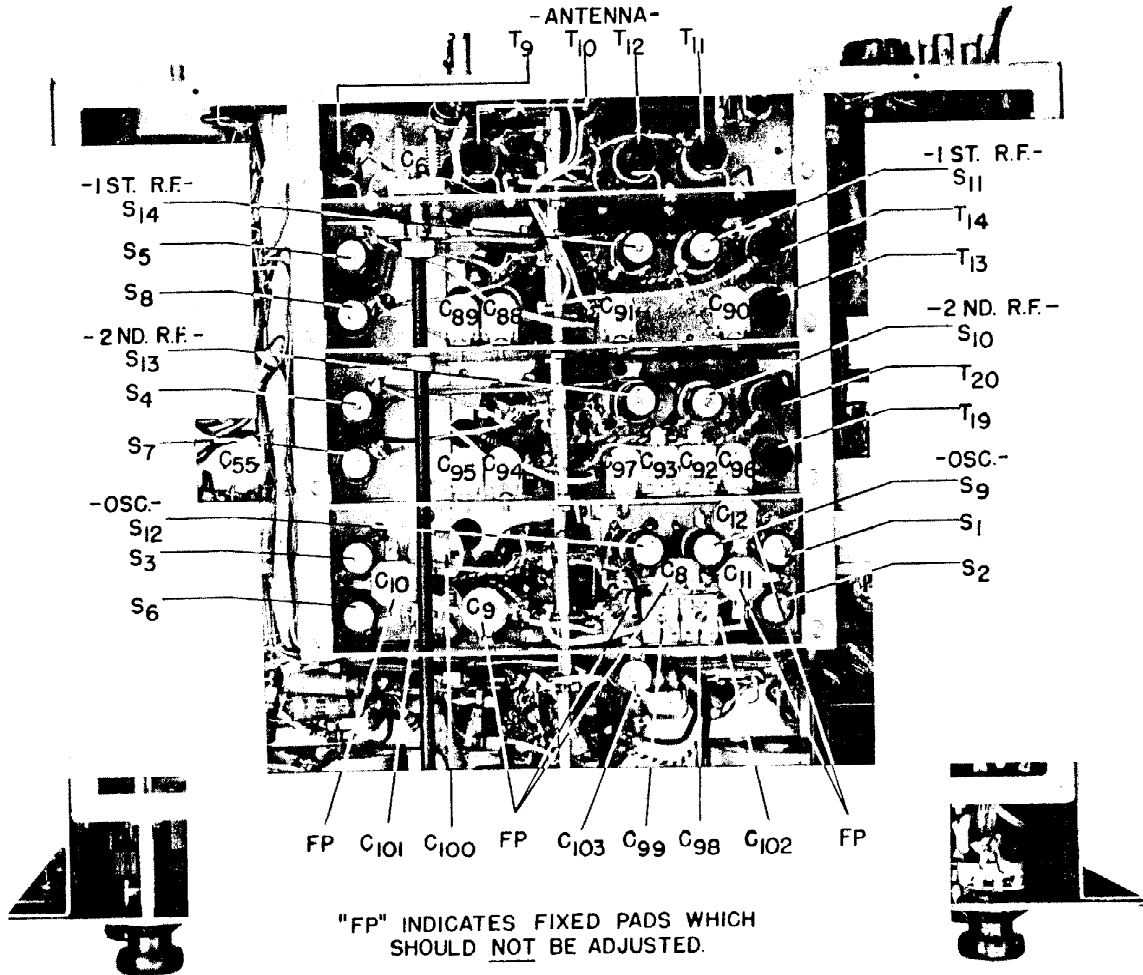

FIG. 12—RF AND OSC ADJUSTMENT LOCATION AND ALIGNMENT PROCEDURE



"FP" INDICATES FIXED PADS WHICH SHOULD NOT BE ADJUSTED.

RF & OSC. ALIGNMENT PROCEDURE

Connect hot lead of signal generator to A₁—through dummy antenna shown in table. Leave jumper connected between A₂ and G. Ground of Generator to Chassis.

Band	Rec. Dial Setting	Sig. Gen. Freq.	Dummy Antenna	HIGH FREQUENCY END		LOW FREQUENCY END	
				Adjust Osc. With	Adjust Trimmers for Max. Gain	Adjust Osc. With	Permeability Tuned By
1	1.4 mc	1.4 mc	200 mmf	C ₉₈	C ₉₂
1	.6	.6	200 mmf	S ₁
2	2.8	2.8	400 ohms	C ₉₉	C ₉₃
2	1.6	1.6	400 ohms	S ₂
3	5.6	5.6	400 ohms	C ₁₀₀	C ₉₄ C ₈₈
3	3.2	3.2	400 ohms	S ₃	S ₄ S ₅
4	11	11	400 ohms	C ₁₀₁	C ₉₅ C ₈₀
4	6	6	400 ohms	S ₆	S ₇ S ₈
5	20	20	400 ohms	C ₁₀₂	C ₉₀ C ₉₀
5	11	11	400 ohms	S ₉	S ₁₀ S ₁₁
6	36	36	400 ohms	C ₁₀₃	C ₉₇ C ₉₁
6	22	22	400 ohms	S ₁₂	S ₁₃ S ₁₄

E

The following measurements made with a 20,000 ohms per volt meter and taken from the socket terminal indicated to ground or receiver chassis. Antenna and ground were disconnected from the receiver when these measurements were taken and the RF and AF gain controls set at maximum. "DL" means Dead Lug but will indicate voltage when used as a tie. Normal tolerance allows a variation of $\pm 10\%$ from the indicated values.

TUBE	FUNCTION	SOCKET TERMINALS								Cap.
		1	2	3	4	5	6	7	8	
V ₁ -6AB7	RF Amp. (1)	0.1	4.15	170	6.3	227
V ₂ -6SK7	RF Amp. (2)	4.35	0.1	4.35	105	6.3	279
V ₃ -6SA7	Mixer	250	100	0.12	4.1	6.3
V ₄ -6SA7	HF Osc.	116	116	0.3	...	6.3	116
V ₅ -6L7	IF Amp. (1) Noise Limiter	245	102	6.3	4	-.075
V ₆ -6SK7	IF Amp. 2	4	...	4	107.5	6.3	235
V ₇ -6B8	2nd Det. S Meter Tube	17.2	-.255	-.255	108	6.3	...	-.17
V ₈ -6B8	AVC Amp.	225.5	0.2	0.2	107	6.3	2
V ₉ -6AB7	Noise Amp.07	1.1	150	6.3	225
V ₁₀ -6H6	Noise Rectifier1	...	17.6 DL	6.3	-.1
V ₁₁ -6J5	Beat Osc.	140	...	-7.4	...	6.3	...	BFO ON ONLY FOR TEST
V ₁₂ -6SC7	1st Audio Amp.	...	140	137	1.4	6.3
V ₁₃ -6V6GT	P.P. Audio Amp.	310	290	...	198 DL	6.3	17
V ₁₄ -6V6GT	P.P. Audio Amp.	310	290	6.3	17
V ₁₅ -5Z3	Rectifier *	320	340 AC	340 AC	320

* 5 V. AC between Terminals 1 & 4

F

GUARANTEE

This receiver is guaranteed to be free from any defect in workmanship and material that may develop within a period of ninety (90) days from date of purchase, under the terms of the standard guarantee, as designated by the Radio Manufacturers Association. Any part or parts that prove defective within this period will be replaced without charge when subjected to examination at our factory, providing such defect, in our opinion, is due to faulty material or workmanship, and not caused by tampering, abuse or normal wear. All such adjustments to be made FOB the factory.

Should this receiver require any adjustments, your dealer or distributor has complete technical service in-

formation, or the factory will be glad to assist you in any problem direct.

Should it be necessary to return any part or parts to the factory, a "Return Material Permit" must be obtained in advance by first writing the Adjustment Department, who will issue due authorization under the terms of the guarantee.

The Hallicrafters Company reserve the right to make changes in design or add improvements to instruments manufactured by them, without incurring any obligation to install the same in any instrument previously purchased.

All Hallicrafters receivers are built under patents of Radio Corporation of America and Hazeltine Corporation

6. LIST OF REPLACEMENT PARTS MODEL SX-28

SYMBOL	NAME AND FUNCTION	DESCRIPTION	MFGR.	MANUFACTURER'S PART NUMBER	HALLICRAFTER'S PART NUMBER
C ₁	Capacitor - Band 1 oscillator tuning (in parallel with C ₂)	250 mmfd max. capacity variable air	RC		
C _{1.1}	Capacitor - Band 1 mixer tuning (in parallel with C _{2.1})	Same as C ₁			
C _{1.2}	Capacitor - Band 1 antenna tuning (in parallel C _{2.2})	Same as C ₁			
C ₂	Capacitor - Bands 2, 3, 4, 5 and 6 oscillator tuning	187.5 mmfd. max. capacity variable air	RC		C ₁ , C _{1.1} , C _{1.2} , C ₂ , C _{2.1} , C _{2.2} , and C _{2.3} on same frame and ganged together Unit 48B050
C _{2.1}	Capacitor - Bands 2, 3, 4, 5 and 6 mixer tuning	Same as C ₂			
C _{2.2}	Capacitor - Bands 2, 3, 4, 5 and 6 2nd R.F. tuning	Same as C ₂			
C _{2.3}	Capacitor - Bands 2, 3, 4, 5 and 6 1st R.F. tuning	Same as C ₂			
C ₃	Capacitor - Bandsread oscillator tuning (80 and 20 meter bands)	15 mmfd. max. capacity variable air	RC		
C _{3.1}	Capacitor - Bandsread mixer tuning (80 and 20 meter bands)	Same as C ₃			
C _{3.2}	Capacitor - Bandsread 2nd R.F. tuning (80 and 20 meter bands)	Same as C ₃			
C _{3.3}	Capacitor - Bandsread 1st R.F. tuning (80 and 20 meter bands)	Same as C ₃			
C ₄	Capacitor - Bandsread oscillator tuning (80 and 40 meter bands)	25 mmfd. max. capacity variable air	RC		
C _{4.1}	Capacitor - Bandsread mixer tuning (80 and 40 meter bands)	Same as C ₄			
C _{4.2}	Capacitor - Bandsread 2nd R.F. tuning (80 and 40 meter bands)	Same as C ₄			

LIST OF REPLACEMENT PARTS - Continued

SYMBOL	NAME AND FUNCTION	DESCRIPTION	MFGR.	MANUFACTURER'S PART NUMBER	HALLCRAFTER'S PART NUMBER
C _{4.3}	Capacitor - Bandsread 1st RF tuning (80 and 40 meter bands)	Same as C ₄			
C ₅	Capacitor - Bandsread oscillator tuning (80 and 10 meter bands)	28 mmfd. max. capacity variable air	RC		C ₃ , C _{3.1} , C _{3.2} , C _{3.3} , C ₄ , C _{4.1} , C _{4.2} , C _{4.3} , C ₅ , C _{5.1} , C _{5.2} , C _{5.3} on same frame and ganged together Unit 485031
C _{5.1}	Capacitor - Bandsread mixer tuning (80 and 10 meter bands)	Same as C ₅			
C _{5.2}	Capacitor - Bandsread 2nd RF tuning (80 and 10 meter bands)	Same as C ₅			
C _{5.3}	Capacitor - Bandsread 1st RF tuning (80 and 10 meter bands)	Same as C ₅			
C ₆	Capacitor-Antenna transformer trimmer Manual control-all bands	5-50 mmfd. variable air	RC		48A055
C ₇	Capacitor - Oscillator padding - Band 6	2160 mmfd. (nominal) -variable mica compression	UE	#1846	44A063
C ₈	Capacitor - Oscillator padding - Band 5	2962 mmfd. (nominal) -variable mica compression	UE	#1842	44B061
C ₉	Capacitor - Oscillator padding - Band 4	2276 mmfd. (nominal) -variable mica compression	UE	#1841	44A060
C ₁₀	Capacitor - Oscillator padding - Band 3	1600 mmfd. (nominal) -variable mica compression	UE	#1845	44A059
C ₁₁	Capacitor - Oscillator padding - Band 2	576 mmfd. (nominal) -variable mica compression	UE	#1844	44A058
C ₁₂	Capacitor - Oscillator padding - Band 1	515 mmfd. (nominal) -variable mica compression	UE	#1843	44A057
C ₁₃	Capacitor - Oscillator stabilization	Temperature compensating	UE	S-2739	44A062
C ₁₄	Capacitor - 1st P.F. -(V ₁) Cathode by-pass	.02 mfd. -10% + 40% 400 v. dc. working tubular paper	SP		46AW2037
C ₁₅	Capacitor - 1st P.F. -(V ₁) screen by-pass	Same as C ₁₄			

LIST OF REPLACEMENT PARTS - Continued

SYMBOL	NAME AND FUNCTION	DESCRIPTION	MFR.	MANUFACTURER'S PART NUMBER	HALLICRAFTER'S PART NUMBER
C16	Capacitor - 1st R.F.-(V ₁) plate return by-pass (transformer primary isolation)	.02 mfd. -10% + 40% 500 v. dc. working tubular paper	SP		46AY203J
C17	Capacitor - 2nd R.F.-(V ₂) grid return by-pass (transformer secondary isolation)	.05 mfd. -10% + 40% 200 v. dc. working tubular paper	SP		46AU503J
C18	Capacitor - 2nd R.F.-(V ₂) cathode and suppressor by-pass	Same as C14			
C19	Capacitor - 2nd R.F.-(V ₂) screen by-pass	Same as C14			
C20	Capacitor - 2nd R.F.-(V ₂) plate return by-pass (transformer primary isolation)	Same as C16			
C21	Capacitor - Mixer (V ₃) grid return by-pass (transformer secondary isolation)	Same as C17			
C22	Capacitor - Mixer (V ₃) cathode by-pass	Same as C14			
C23	Capacitor - Mixer (V ₃) screen by-pass	Same as C14			
C24	Capacitor - Mixer (V ₃) plate return by-pass (T ₁ primary isolation)	Same as C16			
C25	Capacitor - 1st I.F.-(V ₅) grid return by-pass (T ₁ secondary)	2000 mmfd. ± 20% 500 v. dc. working mica	A CD	Type 1467 Type 1W	47BV202F
C26	Capacitor - 1st I.F.-(V ₅) cathode by-pass	Same as C17			
C27	Capacitor - 1st I.F.-(V ₅) screen by-pass	Same as C14			
C28	Capacitor - 1st I.F.-(V ₅) plate return by-pass (T ₂ primary isolation)	Same as C16			
C29	Capacitor - "XTAL-Medium" adjustment	2-6 mmfd. variable ceramic	CRL	820A	44A079
C30	Capacitor - "XTAL-Sharp" adjustment	4-20 mmfd. variable ceramic	CRL	820B	44A078
C31	Capacitor - "I.F.-Sharp" adjustment	Same as C30			

LIST OF REPLACEMENT PARTS - Continued

SYMBOL	NAME AND FUNCTION	DESCRIPTION	MFR.	MANUFACTURER'S PART NUMBER	HALLICRAFTER'S PART NUMBER
C32	Capacitor - Crystal phasing adjustment Manual Control	5-25 mmfd, variable air	RC		48A039
C33	Capacitor - 2nd I.F. (V_5) grid return by-pass (T_2 secondary)	Same as C14			
C34	Capacitor - 2nd I.F. (V_5) cathode and suppressor by-pass	Same as C17			
C35	Capacitor - 2nd I.F. (V_5) screen by-pass	Same as C14			
C36	Capacitor - 2nd I.F. (V_6) plate return by-pass (T_3 primary isolation)	Same as C16			
C37	Capacitor - Diode return by-pass (R.F. filter)	50 mmfd. $\pm 20\%$ 500 v. dc. working mica	A CD	Type 1468 Type 5W	47BU500F
C38	Capacitor - 2nd RF coupling Band 2 (V_2 to V_3)	5-6 $\frac{1}{2}$ mmfd. fixed ceramic 500 v. dc. working	CRL	Class D	47A005
C39	Capacitor - AVC by-pass at 2nd detector (V_7)	Same as C14			
C40	Capacitor - R.F. by-pass (plate of V_{12} 1st audio)	500 mmfd. $\pm 20\%$ 500 v. dc. working mica low loss	A CD	Type 1468L Type 5WL	47BU501F-L
C41	Capacitor - 1st audio (V_{12}) cathode by-pass	40 mfd. -10% +40% 25 v. dc. working electrolytic	SP		C41 and C44 Part of 42A032
C42	Capacitor - Tone control condenser	Same as C16			
C43	Capacitor - Bass choke (CH_2) resonating condenser	5000 mmfd. $\pm 10\%$ 300 v. dc. working mica	A CD	Type 1467 Type 1W	47BV502F
C44	Capacitor - 1st audio (V_{12}) plate supply isolation and stabilization	10 mfd. -10% +40% 300 v. dc. working electrolytic	SP		C41 and C44 Part of 42A032
C45	Capacitor - 1st audio coupling condenser (V_{12} to V_{14})	.05 mfd. -10% +40% 400 v. dc. working tubular paper	SP		46AW503J

LIST OF REPLACEMENT PARTS - Continued

SYMBOL	NAME AND FUNCTION	DESCRIPTION	MFR.	MANUFACTURER'S PART NUMBER	HALLICRAFTER'S PART NUMBER
C ₄₆	Capacitor - Phase inverter plate coupling condenser (V ₁₂ to V ₁₃)	Same as C ₄₅			
C ₄₇	Capacitor - Audio power cathode by-pass (V ₁₃ & V ₁₄)	40 mfd. -10% +40% 25 v. dc. working electrolytic	SP	C ₄₇ and C ₄₈ Part of 42A031	
C ₄₈	Capacitor - Power supply output filter	30 mfd. -10% +40% 400 v. dc. working electrolytic			
C ₄₉	Capacitor - Power supply input filter	30 mfd. -10% +40% 450 v. dc. working electrolytic	SP	42A030	
C ₅₀	Capacitor - Detector to AF gain control coupling condenser	Same as C ₁₄			
C ₅₁	Capacitor - Power line by-pass	.01 mfd. -10% +40% 600 v. dc. working tubular paper	SP	46AV105J	
C ₅₂	Capacitor - Power line by-pass	Same as C ₅₁			
C ₅₃	Capacitor - ANL by-pass	Same as C ₁₇			
C ₅₄	Capacitor - ANL cathode by-pass (V ₁₀)	Same as C ₄₅			
C ₅₅	Capacitor - Wave trap resonating trimmer	50 mmfd. (nominal) -variable mica compression	SWI	SW-1530	C ₅₅ and CH ₃ Part of 53A012
C ₅₆	Capacitor - Noise amplifier (V ₉) plate return by-pass (T ₅ primary isolation)	Same as C ₁₆			
C ₅₇	Capacitor - Noise amplifier (V ₉) screen by-pass	Same as C ₁₄			
C ₅₈	Capacitor - Noise amplifier (V ₉) cathode by-pass	Same as C ₁₇			
C ₅₉	Capacitor - Noise amplifier (V ₉) grid circuit isolation	Same as C ₁₇			
C ₆₀	Capacitor - Noise amplifier (V ₉) grid coupling condenser	Same as C ₃₇			

LIST OF REPLACEMENT PARTS - Continued

SYMBOL	NAME AND FUNCTION	DESCRIPTION	MFG#	MANUFACTURER'S PART NUMBER	HALLICRAFTER'S PART NUMBER
C61	Capacitor - AVC amplifier (V ₈) grid coupling condenser	250 mmfd. ±20% 500 v. dc. working mica (inside T ₁)	A CD	Type 1468 Type 5W	47EU251F
C62	Capacitor - AVC amplifier (V ₈) screen-by-pass	Same as C ₁₄			
C63	Capacitor - AVC amplifier (V ₈) cathode and suppressor by-pass	Same as C ₁₇			
C64	Capacitor - RF filter - diode return AVC amplifier (V ₉)	100 mmfd. ±20% 500 v. dc. working mica	A CD	Type 1468 Type 5W	47EU101F
C65	Capacitor - AVC by-pass Bands 2,3,4,5 and 6	Same as C ₁₄			
C66	Capacitor - AVC by-pass Band 1	Same as C ₁₇			
C67	Capacitor - AVC amplifier (V ₈) plate return by-pass (T ₆ primary isolation)	Same as C ₁₆			
C68	Capacitor - Injector grid coupling (V ₃)	Same as C ₃₇			
C69	Capacitor - Oscillator grid coupling (V ₄)	Same as C ₃₇			
C70	Capacitor - Oscillator plate return by-pass (T ₃₀ primary isolation)	Same as C ₂₅			
C71	Capacitor - BFC grid coupling (V ₁₁)	Same as C ₈₄			
C72	Capacitor - BFC pitch control - Manual control	5-25 mmfd. variable air	RC		48AC64
C73	Capacitor - BFC fixed resonating condenser	500 mmfd. ±5% 500 v. dc. working silver-mica (inside T ₄)	A CD	Type 1469 Type 5R	47ET501D
C74	Capacitor - BFO plate by-pass (V ₁₁)	.01 MFD -10%+40% 600 v. dc. working, tubular, paper (Braided leads)			
C75	Capacitor - BFO to diode coupling	2 mmfd. - twisted leads			

LIST OF REPLACEMENT PARTS - Continued

SYMBOL	NAME AND FUNCTION	DESCRIPTION	MFR.	MANUFACTURER'S PART NUMBER	HALLICRAFTER'S PART NUMBER
C76	Capacitor - Impedance equalization (with R ₄₃) T ₈ primary	Same as C25			
C77	Capacitor - 1st R.F. (V ₁) grid return by-pass (transformer secondary isolation)	Same as C17			
C78	Capacitor - 1st RF coupling - Band 6 (V ₁ to V ₂)	10 mmfd. ±10% 500 v. dc. working fixed ceramic	CPL	Class D	47A006
C79	Capacitor - 1st RF coupling - Band 5 (V ₁ to V ₂)	Same as C38			
C80	Capacitor - 1st RF coupling - Band 4 (V ₁ to V ₂)	Same as C38			
C81	Capacitor - 1st RF coupling - Band 3 (V ₁ to V ₂)	2 mmfd. twisted leads			
C82	Capacitor - 2nd RF coupling - Band 6 (V ₂ to V ₃)	Same as C78			
C83	Capacitor - 2nd RF coupling - Band 5 (V ₂ to V ₃)	Same as C38			
C84	Capacitor - 2nd RF coupling - Band 4 (V ₂ to V ₃)	2 mmfd. twisted leads			
C85	Capacitor - 2nd RF coupling - Band 3 (V ₂ to V ₃)	2 mmfd. twisted leads			
C86	Capacitor - Oscillator plate de-coupling	Same as C40			
C87	Capacitor - R.F. gain control by-pass	.25 mfd. -10% +40% 200 v. dc. working tubular paper	SP		46AT254J
C88	Capacitor - 1st R.F. transformer trimmer (T ₁₅) Band 3	4-20 mmfd. variable ceramic	CRL	820-B, with special Hallicrafter's bracket	44A076
C89	Capacitor - 1st R.F. transformer trimmer (T ₁₆) Band 4	Same as C88			
C90	Capacitor - 1st R.F. transformer trimmer (T ₁₇) Band 5	Same as C88			

LIST OF REPLACEMENT PARTS - Continued

SYMBOL	NAME AND FUNCTION	DESCRIPTION	MFR.	MANUFACTURER'S PART NUMBER	HALLICRAFTER'S PART NUMBER
C91	Capacitor - 1st R.F. transformer trimmer (T18) Band 6	Same as C98			
C92	Capacitor - 2nd R.F. transformer trimmer (T19) Band 1	3-25 mmfd. variable mica compression	UE		C92 and C93 Part of 44A052
C93	Capacitor - 2nd R.F. transformer trimmer (T20) Band 2	Same as C92			
C94	Capacitor - 2nd R.F. transformer trimmer (T21) Band 3	2-5 mmfd. variable ceramic	CRL	820-A, with special Halli-crafter's bracket	44A077
C95	Capacitor - 2nd R.F. transformer trimmer (T22) Band 4	Same as C98			
C96	Capacitor - 2nd R.F. transformer trimmer (T23) Band 5	Same as C98			
C97	Capacitor - 2nd R.F. transformer trimmer (T24) Band 6	Same as C98			
C98	Capacitor - Oscillator transformer trimmer (T25) Band 1	Same as C92			
C99	Capacitor - Oscillator transformer trimmer (T26) Band 2	Same as C92			
C100	Capacitor - Oscillator transformer trimmer (T27) Band 3	5-25 mmfd. variable air	SI		48A049
C101	Capacitor - Oscillator transformer trimmer (T28) Band 4	Same as C100			
C102	Capacitor - Oscillator transformer trimmer (T29) Band 5	Same as C100			
C103	Capacitor - Oscillator transformer trimmer (T30) Band 6	1-10 mmfd. variable air	MV	22-5230	48A051

LIST OF REPLACEMENT PARTS - Continued

SYMBOL	NAME AND FUNCTION	DESCRIPTION	MPOR.	MANUFACTURER'S PART NUMBER	HALICRAFTER'S PART NUMBER
C ₁₀₄	Capacitor - Primary resonating (T ₁) 1st I.F. transformer	275 mmfd. silver mica (inside T ₁)	SI		C ₁₀₄ and C ₁₀₅ part of 50B082B
C ₁₀₅	Capacitor - Secondary resonating (T ₁) 1st I.F. transformer	Same as C ₁₀₄ (inside T ₁)			
C ₁₀₆	Capacitor - Primary resonating (T ₂) 2nd I.F. transformer	125 mmfd. silver mica (inside T ₂)	SI		C ₁₀₆ and C ₁₀₇ part of 50B081
C ₁₀₇	Capacitor - Secondary resonating (T ₂) 2nd I.F. transformer	85 mmfd. silver mica (inside T ₂)	SI		
C ₁₀₈	Capacitor - Trimmer - Diode Transformer primary (T ₃)	70-90 mmfd. variable ceramic (inside T ₃)	SWI		C ₁₀₈ and C ₁₀₉ part of 50B083
C ₁₀₉	Capacitor - Trimmer - Diode transformer secondary (T ₃)	Same as C ₁₀₈ (inside T ₃)			
C ₁₁₀	Capacitor - Trimmer - ANL transformer primary (T ₅)	80 mmfd. (nominal) variable mica compression (inside T ₅)	SWI		C ₁₁₀ and C ₁₁₁ part of 50B097
C ₁₁₁	Capacitor - Trimmer - ANL transformer secondary (T ₅)	Same as C ₁₁₀ (inside T ₅)			
C ₁₁₂	Capacitor - Primary resonating (T ₆) AVC transformer	100 mmfd. mica (inside T ₆)	SWI		C ₁₁₂ part of 50E134
C ₁₁₃	Capacitor - Secondary resonating (T ₆) AVC transformer	Same as C ₁₁₀ (inside T ₆)			C ₁₁₃ part of 50E134
R ₁	Resistor - AVC return for V ₁	100,000 ohm ± 20% - 1/2 watt - Insulated carbon	ER	Type 504	23BX104F
R ₂	Resistor - R.F. gain manual control	10,000 ohm ± 20% potentiometer curve No. 8 reversed	CT		25C066
R ₃	Resistor - Bias - 1st R.F. cathode (V ₁)	300 ohm ± 10% - 1/2 watt - Insulated carbon	ER	Type 504	23BX301E

LIST OF REPLACEMENT PARTS - Continued

SYMBOL	NAME AND FUNCTION	DESCRIPTION	MFG.	MANUFACTURER'S PART NUMBER	ALLICRAFTER'S PART NUMBER
R ₄	Resistor - 1st R.F. screen isolator (V ₁)	25,000 ohm - 1 watt - ± 10% Insulated carbon	ER	Type 518	23E253E
R ₅	Resistor - 1st R.F. plate circuit isolation	1,000 ohm ± 20% - 1/2 watt - Insulated carbon	ER	Type 504	23E102F
R ₆	Resistor - Oscillator (V ₄) primary isolation	6,800 ohm ± 10% - 2 watt - Insulated carbon	IRC	Type 5T2	23E682E
R ₇	Resistor - AVC return for V ₂	Same as R ₁			
R ₈	Resistor - Bias - 2nd R.F. cathode (V ₂)	Same as R ₃			
R ₉	Resistor - 2nd R.F. screen isolation (V ₂)	Same as R ₅			
R ₁₀	Resistor - 2nd R.F. (V ₂) plate circuit isolation	3000 ohm ± 20% - 1/2 watt - Insulated carbon	ER	Type 504	23E302F
R ₁₁	Resistor - AVC return for V ₃	Same as R ₁			
R ₁₂	Resistor - Bias - Mixer cathode (V ₃)	400 ohm ± 10% - 1/2 watt - Insulated carbon	ER	Type 504	23E740E
R ₁₃	Resistor - Mixer screen isolation (V ₃)	Same as R ₅			
R ₁₄	Resistor - Mixer (V ₃) plate circuit isolation	Same as R ₁₀			
R ₁₅	Resistor - AVC return for V ₅	Same as R ₁			
R ₁₆	Resistor - Bias - 1st IF cathode (V ₅) Bands 1, 2 and 6	270 ohm ± 10% - 1/2 watt - Insulated carbon	ER	Type 504	23E271E
R ₁₇	Resistor - 1st I.F. screen isolator (V ₅)	Same as R ₆			
R ₁₈	Resistor - 1st I.F. plate circuit isolation	Same as R ₁₀			

LIST OF REPLACEMENT PARTS - Continued

SYMBOL	NAME AND FUNCTION	DESCRIPTION	MFG.	MANUFACTURER'S PART NUMBER	HALLICRAFTER'S PART NUMBER
R ₁₉	Resistor - 2nd I.F. (V ₆) grid leak	Same as R ₁	ER	Type 504	23BX504F
R ₂₀	Resistor - 2nd I.F. (V ₆) grid leak	500,000 ohm ± 20% - 1/2 watt - Insulated carbon	ER	Type 504	23BX251E
R ₂₁	Resistor - Bias - 2nd I.F. cathode (V ₆)	250 ohm ± 10% - 1/2 watt - Insulated carbon	ER	Type 504	23BX162E
R ₂₂	Resistor - 2nd I.F. screen isolation (V ₆)	Same as R ₅			
R ₂₃	Resistor - 2nd I.F. plate circuit isolation	Same as R ₁₀			
R ₂₄	Resistor - Diode load & AVC voltage divider	Same as R ₁			
R ₂₅	Resistor - Diode load & AVC voltage divider	Same as R ₂₀			
R ₂₆	Resistor - Bias - 1st I.F. cathode (V ₅) Bands 3 & 5 (in series with R ₁₆)	1800 ohm ± 10% - 1/2 watt - Insulated carbon	ER	Type 504	23BX162E
R ₂₇	Resistor - AVC return for V ₅ & V ₇	Same as R ₂₀			
R ₂₈	Resistor - Fixed shunt across carrier level meter	100 ohm ± 20% - 1/2 watt - Insulated carbon	ER	Type 504	23BX101F
R ₂₉	Resistor - Variable shunt across carrier level meter. Manual "Zero set"	500 ohm ± 20% - variable potentiometer curve No. 7 reversed	CT		25C022
R ₃₀	Resistor - Voltage dropping plate supply to V ₇ thru meter	27,000 ohm ± 10% - 2 watt - Insulated carbon	IRC	Type BT2	23BY273E
R ₃₁	Resistor - Voltage divider	11,000 ohm ± 10% - 1/2 watt metal clad	CS MT		
R ₃₂	Resistor - Voltage divider	4000 ohm ± 10% - 7 watt metal clad	CS MT		R ₃₁ and R ₃₂ part of 24A046

LIST OF REPLACEMENT PARTS - Continued

SYMBOL	NAME AND FUNCTION	DESCRIPTION	MFR.	MANUFACTURER'S PART NUMBER	HALLICRAFTER'S PART NUMBER
R33	Resistor - Variable AF gain control Manual operation	500,000 ohm \pm 20% - variable potentiometer curve No. 6	CT		25C065
R34	Resistor - Bias - 1st audio cathode (V_{12})	Same as R5			
R35	Resistor - Variable tone control-Manual operation	500,000 ohm \pm 20% - variable potentiometer curve No. 1	CT		25C064
R36	Resistor - Audio phase inverter plate load (V_{12})	Same as R1			
R37	Resistor - 1st audio plate load (V_{12})	Same as R1			
R38	Resistor - 1st audio plate de-coupling	50,000 ohm \pm 20% - 1/2 watt - Insulated carbon	ER	Type 504	23BX503F
R39	Resistor - Grid leak (V_{12} & V_{14}) & grid voltage divider - with R41	200,000 ohm \pm 20% - 1/2 watt - Insulated carbon	ER	Type 504	23BX204F
R40	Resistor - Grid leak (V_{13})	250,000 ohm \pm 20% - 1/2 watt - Insulated carbon	ER	Type 504	23BX254F
R41	Resistor - Grid leak for V_{14} & grid voltage divider for V_{12} (with R39)	Same as R40			
R42	Resistor - Bias - Audio power stage (V_{13} & V_{14}) cathode	220 ohm \pm 10% - 2 watt - Wire wound	IRC	Type BW2	24BV221E
R43	Resistor - Impedance equalization - (with C76) T8 primary	20,000 ohm \pm 10% - 2 watt - carbon	CEL	Type 316	23A001
R44	Resistor - Audio power dissipation (Head- phone operation)	5000 ohm \pm 20% - 10 watt - wire wound - vitreous enamel	U	Type CC	24BG502E
R45	Resistor - BFO plate load (V_{11})	Same as R43			

LIST OF REPLACEMENT PARTS - Continued

SYMBOL	NAME AND FUNCTION	DESCRIPTION	MFCT.	MANUFACTURER'S PART NUMBER	ALLIANT'S PART NUMBER
R46	Resistor - BFO grid leak (V ₁₁)	Same as R ₃₈			
R47	Resistor - Spurious oscillation suppressor (V ₄)	8 ohm ± 20% - 1/2 watt Insulated carbon	ER	Type 504	23A008
R48	Resistor - Minimum bias - ANL cathode (V ₁₀)	Same as R ₁			
R49	Resistor - ANL diode load (V ₁₀)	1 megohm ± 20% - 1/2 watt	CRL	Type 710	23EX106F
R50	Resistor - Noise amplifier plate circuit isolation - I ₅ primary.	500 ohm ± 20% - 1/2 watt - Insulated carbon	ER	Type 504	23EX501F
R51	Resistor - Screen isolation - Noise amplifier (V ₉)	20,000 ohm ± 20% - 1 watt - carbon	CRL	Type 314	23A003
R52	Resistor - Bias - Noise amplifier (V ₉) Bleeder from 100 v. to R ₅₃	Same as R ₃₈			
R53	Resistor - Variable bias - Noise amplifier. Manual control	50,000 ohm ±20% - potentiometer. Curve No. 6 reversed	CT		25C067
R54	Resistor - Minimum bias - Noise amplifier cathode V ₉	35 ohm ± 20% - 1/2 watt carbon	CRL	Type 310	23A004
R55	Resistor - Grid leak - (V ₉) - Noise amplifier	Same as R ₂₀			
R56	Resistor - Screen isolation - AVC amplifier (V ₈)	Same as R ₅			
R57	Resistor - AVC return for noise amplifier (V ₉)	Same as R ₁			
R58	Resistor - Bias - AVC amplifier cathode (V ₈)	200 ohm ± 10% - 1/2 watt - Insulated carbon	ER	Type 504	23BX201E
R59	Resistor - Diode load and amplified AVC voltage divider (with R ₆₀)	Same as R ₁			

LIST OF REPLACEMENT PARTS - Continued

SYMBOL	NAME AND FUNCTION	DESCRIPTION	MFCR.	MANUFACTURER'S PART NUMBER	HALLICRAFTER'S PART NUMBER
R50	Resistor - Diode load & amplified AVC voltage divider (with R ₅₉)	Same as R ₄₀			
R61	Resistor - Amplified AVC isolation	Same as R ₂₀			
R62	Resistor - Grid leak - AVC amplifier (V ₈)	Same as R ₂₀ (inside T ₁)			
R63	Resistor - Plate circuit isolation AVC amplifier (V ₈)	Same as R ₁₀			
R64	Resistor - Amplified AVC isolation	Same as R ₂₀			
R65	Resistor - Injector grid leak - mixer tube (V ₃)	Same as R ₃₈			
R66	Resistor - Oscillator grid leak (V ₄)	Same as R ₃₈			
R67	Resistor - Spurious oscillation suppressor (V ₁) Band 1	Same as R ₅₀			
R68	Resistor - Bias - 1st I.F. cathode (V ₅) Band 4 - in series with R ₁₆	1200 ohm±10% 1/2 watt - Insulated carbon	ER	Type 5C4	23BA122E
R69	Resistor - Primary shunt - Noise amplifier transformer (V ₅)	Same as R ₁			
R70	Resistor - ANL circuit (V ₁₀) balance	Same as R ₄₉			
R71	Resistor - External heat dissipation for oscillator plate decoupling	5000 ohm±10% 1 watt - carbon	CRL	Type 314	23A005
R72	Resistor - Spurious oscillation suppressor (V ₁) Band 2	Same as R ₅₀			
R73	Resistor - Spurious oscillation suppressor (V ₄)	Same as R ₄₇			
R74	Resistor - Spurious oscillation suppressor (V ₁)	6.8 ohm 20% 1/2 watt - carbon	ER	Type 504	23A018
T1	Transformer - 1st IF	455 KC - fixed capacity Variable iron core tuning	SI		50B082
T2	Transformer - 2nd IF and crystal network	455 KC - fixed capacity Variable iron core tuning	SI		50B081

LIST OF REPLACEMENT PARTS - Continued

SYMBOL	NAME AND FUNCTION	DESCRIPTION	MFCR.	MANUFACTURER'S PART NUMBER	HALLICRAFTER'S PART NUMBER
T ₃	Transformer - Diode IF	455 KC - Ceramic trimmer tuning	SWI		50B085
T ₄	Transformer - BFO	455 KC - fixed capacity Variable iron core tuning	SWI		54B014
T ₅	Transformer - ANL amplifier	455 KC - compression mica trimmer tuning	SWI		50B097
T ₆	Transformer - AVC amplifier	455 KC - Variable iron core tuning	SWI		50B134
T ₇	Transformer - Power	Secondary winding - 580 v. ac, C.T. at 185 MA Filament winding - 6.3 v. ac, 5.5 A Rectifier winding - 5 v. ac, at 3 A	GT ST		52B033 Pri. 117 v. 50-60 cycles 52B034 Pri. 115- 230 v. 25-50 cycles
T ₈	Transformer - Audio output	10,000 ohm C.T. primary 100-500-5000 ohm secondary	GT		55B009
T ₉	Transformer - Antenna - Band 3	3.0 - 5.8 MC air core	SWI		51E276
T ₁₀	Transformer - Antenna - Band 4	5.8 - 11.5 MC air core	SWI		51E277
T ₁₁	Transformer - Antenna - Band 5	10.5 - 21 MC air core	SWI		51E278
T ₁₂	Transformer - Antenna - Band 6	21 - 43 MC air core	SWI		51E279
T ₁₃	Transformer - Antenna - Band 1	550 - 1600 KC air core	SWI		51E274
T ₁₄	Transformer - Antenna - Band 2	1.6 - 3.0 MC air core	SWI		51E275
T ₁₅	Transformer - R.F. - Band 3	3.0 - 5.8 MC Variable-iron core	SWI		51E280
T ₁₆	Transformer - R.F. - Band 4	5.8 - 11.5 MC Variable-iron core	SWI		51E281
T ₁₇	Transformer - R.F. - Band 5	10.5 - 21 MC Variable-iron core	SWI		51E282

LIST OF REPLACEMENT PARTS - Cont inued

SYMBOL	NAME AND FUNCTION	DESCRIPTION	MFR.	MANUFACTURER'S PART NUMBER	HALLCRAFTER'S PART NUMBER
T18	Transformer - R.F. - Band 6	21 - 42 MC Variable-iron core	SWI		51E283
T19	Transformer - Mixer input - Band 1	560 - 1600 KC air core	SWI		51E284
T20	Transformer - Mixer input - Band 2	1.6 - 3.0 MC air core	SWI		51E285
T21	Transformer - Mixer input - Band 3	3.0 - 5.8 MC Variable-iron core	SWI		51E286
T22	Transformer - Mixer input - Band 4	5.8 - 11.5 MC Variable-iron core	SWI		51E287
T23	Transformer - Mixer input - Band 5	10.5 - 21 MC Variable-iron core	SWI		51E288
T24	Transformer - Mixer input - Band 6	21 - 42 MC Variable-iron core	SWI		51E289
T25	Transformer - Oscillator - Band 1	560 - 1600 KC Variable-iron core	SWI		51E290
T26	Transformer - Oscillator - Band 2	1.6 - 3.0 MC Variable-iron core	SWI		51E291
T27	Transformer - Oscillator - Band 3	3 - 5.8 MC Variable-iron core	SWI		51E292
T28	Transformer - Oscillator - Band 4	5.8 - 11.5 MC Variable-iron core	SWI		51E293
T29	Transformer - Oscillator - Band 5	10.5 - 21 MC Variable-iron core	SWI		51E294
T30	Transformer - Oscillator - Band 6	21 - 42 MC Variable-iron core	SWI		51E295
CH1	Inductor - Power supply filter	15 henries \pm 10% at 100 milliamperes dc. - dc. resistance - 300 ohms \pm 10%	GT		56E008

LIST OF REPLACEMENT PARTS - Continued

SYMBOL	NAME AND FUNCTION	DESCRIPTION	MFR.	MANUFACTURER'S PART NUMBER	HALLICRAFTER'S PART NUMBER
CH ₂	Inductor - Bass filter	Inductance - 4 henries ± 10% dc. resistance 220 ohms ± 10%	ST		55B010
CH ₃	Inductor - Wave trap	455 KC - ANL IF filter	SWI		CH ₃ and C55 part of 53R012
J ₁	Jack - Phonograph	Std. tip and sleeve	U	503-C	36B003
J ₂	Jack - Headphone	Std. tip and sleeve	U		36B011
FS ₁	Fuse - Power line	1½ amp. 250 v.	LF	Type 4AG No. 1041	39A320
PL ₁	Plug - D.C. power supply	Octal shorting plug in AC operation	AP		35A003
PL ₂	Plug - A.C. power cord and plug	2 conductor	E		87AC78
SO ₁	Socket - For D.C. power supply	Octal marked "PWR"	AP	MIF-8T	64042
SO ₂	Socket - For remote "send-receive" switch or relay	Two circuit	AL	MIF-6TF	10A009
TS ₁	Terminal - Antenna	Marked - A ₂ A ₁	MM		8A039
TS ₂	Terminal - Speaker	Marked - 5000	MM		8A040
TS ₃	Terminal - Speaker	Marked - 500	MM		8A041
M ₁	Meter - Carrier level	5 milliampere movement	BE		82A007
CX ₁	Crystal - IF filter	455 KC ± 7 KC	BL		19A123

LIST OF REPLACEMENT PARTS - Continued

SYMBOL	NAME AND FUNCTION	DESCRIPTION	MFG.	MANUFACTURER'S PART NUMBER	HALLICRAFTER'S PART NUMBER
SW ₁	Switch - I.F. AVC "ON and OFF"	SW ₁ , SW ₂ , SW ₆ and SW ₇ on same wafer	OM		60A052
SW ₂	Switch - BFO "ON and OFF"				
SW ₃	Switch - Power "ON and OFF"	SPST on rear of R ₃₅	CT		Part of 250064
SW ₄	Switch - Send - Receive	SPST - Bez handle toggle	HH		60A103
SW ₅	Switch - AML amplifier "ON and OFF"	DPST on rear of R ₅₃	CT		SW ₅ and SW ₅₋₁ part of 250067
SW ₅₋₁	Switch - AML diode "ON and OFF"				
SW ₆	Switch - Band 1 R.F. AVC "ON and OFF"	SW ₁ , SW ₂ , SW ₅ and SW ₇ on same wafer	OM		60A052
SW ₇	Switch - Band 2, 3, 4, 5 and 6 R.F. AVC "ON and OFF"				
SW ₈₋₁	Switch - Antenna trimmer band selector	SW ₈₋₁ , SW ₈₋₂ , SW ₈₋₃ and SW ₈₋₄ on same unit	OM		62B025
SW ₈₋₂	Switch - Antenna transformer primary selector				
SW ₈₋₃	Switch - Antenna transformer secondary selector	SW ₈₋₅ , SW ₈₋₆ and SW ₈₋₇ on same unit	OM		66E013
SW ₈₋₄	Switch - Antenna transformer secondary tuning condenser selector				
SW ₈₋₅	Switch - 1st RF transformer primary selector	Same as SW ₈₋₅ , SW ₈₋₆ and SW ₈₋₇	OM		
SW ₈₋₆	Switch - 1st RF transformer secondary selector				
SW ₈₋₇	Switch - 1st RF transformer secondary tuning condenser selector				
SW ₈₋₈	Switch - 2nd RF transformer primary selector				
SW ₈₋₉	Switch - 2nd RF transformer secondary selector				

LIST OF REPLACEMENT PARTS - Continued

SYMBOL	NAME AND FUNCTION	DESCRIPTION	MEGR.	MANUFACTURER'S PART NUMBER	HALLICRAFTER'S PART NUMBER
SW ₈₋₁₀	Switch - 2nd RF transformer secondary tuning condenser selector	Same as SW ₈₋₅ , SW ₈₋₆ , and SW ₈₋₇			
SW ₈₋₁₁	Switch - Oscillator transformer primary selector	SW ₈₋₁₁ , SW ₈₋₁₂ , and SW ₈₋₁₃ on same unit	CM		62B015
SW ₈₋₁₂	Switch - Oscillator transformer secondary selector				
SW ₈₋₁₃	Switch - Oscillator transformer secondary tuning condenser selector				
SW ₈₋₁₄	Switch - 1st IF bias selector (V ₅)	SW ₈₋₁₄ and SW ₈₋₁₅ on same wafer	CM		62B023
SW ₈₋₁₅	Switch - RF AVC voltage selector				
SW ₉₋₁	Switch - 1st IF selectivity selector				
SW ₉₋₂	Switch - 2nd IF selectivity selector	SW ₉₋₁ , SW ₉₋₂ , and SW ₉₋₃ on same unit	OM		60B048
SW ₉₋₃	Switch - Crystal selectivity selector				
SW ₁₀	Switch - Bass "IN and OUT"	SPDT Bat handle toggle	HH		60A102
I ₁	Lamp - Band spread dial	6.3 v. - .25 amp.	GE	#44	39A003
I ₂	Lamp - Main tuning dial	Same as I ₁			
I ₃	Lamp - Meter scale	6.3 v. - .15 amp.	GE	#47	39A004
V ₁	Tube - 1st R.F. amplifier	RF pentode	RCA	Type 6AB7	90X6AB7
V ₂	Tube - 2nd R.F. amplifier	RF pentode	RCA	Type 6SK7	90X6SK7
V ₃	Tube - 1st detector mixer	Penagrid converter	RCA	Type 6SA7	90X6SA7
V ₄	Tube - Oscillator	Same as V ₃			

LIST OF REPLACEMENT PARTS - Continued

SYMBOL	NAME AND FUNCTION	DESCRIPTION	MFR.	MANUFACTURER'S PART NUMBER	HALLICRAFTER'S PART NUMBER
V5	Tube - 1st I.F. amplifier	Pentagrid mixer	RCA	Type 6L7	90X6L7
V6	Tube - 2nd I.F. amplifier	Same as V2			
V7	Tube - 2nd detector	Duplex - diode pentode	RCA	Type 6B8	90X6B8
V8	Tube - AVC amplifier & AVC rectifier	Same as V7			
V9	Tube - Noise amplifier for ANL	Same as V1			
V10	Tube - Noise peak limiter and noise rectifier	Twin diode	RCA	Type 6H6	90X6H6
V11	Tube - BFO oscillator	Triode	RCA	Type 6J5	90X6J5
V12	Tube - 1st audio & phase inverter	Twin triode	RCA	Type 6SC7	90X6SC7
V13	Tube - Audio power amplifier	Beam power	RCA	Type 6V6GI	90X6V6GI
V14	Tube - Audio power amplifier	Same as V13			
V15	Tube - Power supply rectifier	Full wave rectifier	RCA	Type 5Z3	90X5Z3

H. INDEX TO PARTS MANUFACTURERS

SYMBOL	MANUFACTURER	ADDRESS
A	Aerovox Manufacturing Company	New Bedford, Mass.
AL	Alden Products Company	Brockton, Mass.
AP	American Phenolic Corporation	Chicago, Ill.
BE	Beede Electrical Instrument Co.	Chicago, Ill.
BL	Bliley Electric Co.	Erie, Penna.
CD	Cornell-Dubilier Corporation	South Plainfield, N.J.
GRL	Centralab	Milwaukee, Wis.
CS	Clarostat Manufacturing Co.	Brooklyn, N.Y.
CT	Chicago Telephone Supply Co.	Elkhart, Ind.
E	Essex Wire Corporation	Chicago, Ill.
ER	Erie Resistor Company	Erie, Penna.
GE	General Electric Company	Chicago, Ill.
GT	General Transformer Corporation	Chicago, Ill.
H	The Hallcrafters Company	Chicago, Ill.
HH	Hart & Hegeman Electric Company	Hartford, Conn.
IRC	International Resistance Company	Philadelphia, Penna.
LF	Littlefuse Labs	Chicago, Ill.
MN	Meissner Manufacturing Co.	Mt. Carmel, Ill.
MM	Midwest Molding Company	Chicago, Ill.
MT	The Muter Company	Chicago, Ill.
OM	Oak Manufacturing Company	Chicago, Ill.
RC	Radio Condenser Corporation	Chicago, Ill.
RCA	RCA Manufacturing Company	Chicago, Ill.
SI	F. W. Sickles Company	Springfield, Mass.
SP	Sprague Specialties Company	North Adams, Mass.
ST	Standard Transformer Corporation	Chicago, Ill.
SWI	S. W. Inductor Company	Chicago, Ill.
U	Utah Radio Products	Chicago, Ill.
UE	Underwood Electric Co.	Chicago, Ill.

FIG. 12—RF AND OSC ADJUSTMENT LOCATION AND ALIGNMENT PROCEDURE

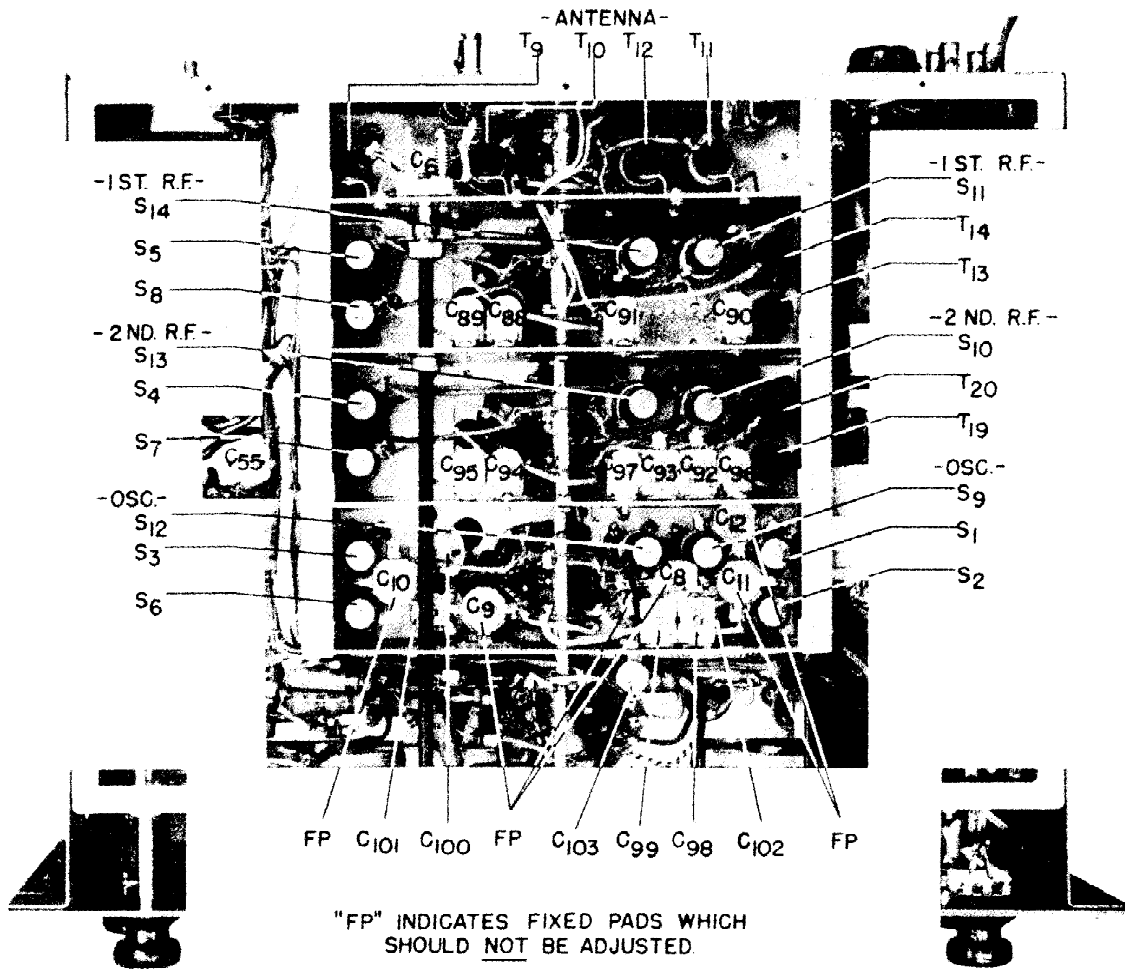

"FP" INDICATES FIXED PADS WHICH SHOULD NOT BE ADJUSTED.

RF & OSC. ALIGNMENT PROCEDURE

Connect hot lead of signal generator to A1—through dummy antenna shown in table. Leave jumper connected between A2 and G. Ground of Generator to Chassis.

Band	Rec. Dial Setting	Sig. Gen. Freq.	Dummy Antenna	HIGH FREQUENCY END		LOW FREQUENCY END		
				Adjust Osc. With	Adjust Trimmers for Max. Gain	Adjust Osc. With	Permeability Tuned By	
1	1.4 mc	1.4 mc	200 mmf	C ₉₈	C ₉₂	
1	.6	.6	200 mmf	S ₁	
2	2.8	2.8	400 ohms	C ₉₉	C ₉₃	
2	1.6	1.6	400 ohms	S ₂	
3	5.6	5.6	400 ohms	C ₁₀₀	C ₉₄ C ₈₈	S ₃	S ₄ S ₅
3	3.2	3.2	400 ohms	S ₅	
4	11	11	400 ohms	C ₁₀₁	C ₉₅ C ₈₉	
4	6	6	400 ohms	S ₆	S ₇ S ₈
5	20	20	400 ohms	C ₁₀₂	C ₉₈ C ₉₀	
5	11	11	400 ohms	S ₉	S ₁₀ S ₁₁
6	36	36	400 ohms	C ₁₀₃	C ₉₇ C ₉₁	
6	22	22	400 ohms	S ₁₂	S ₁₃ S ₁₄

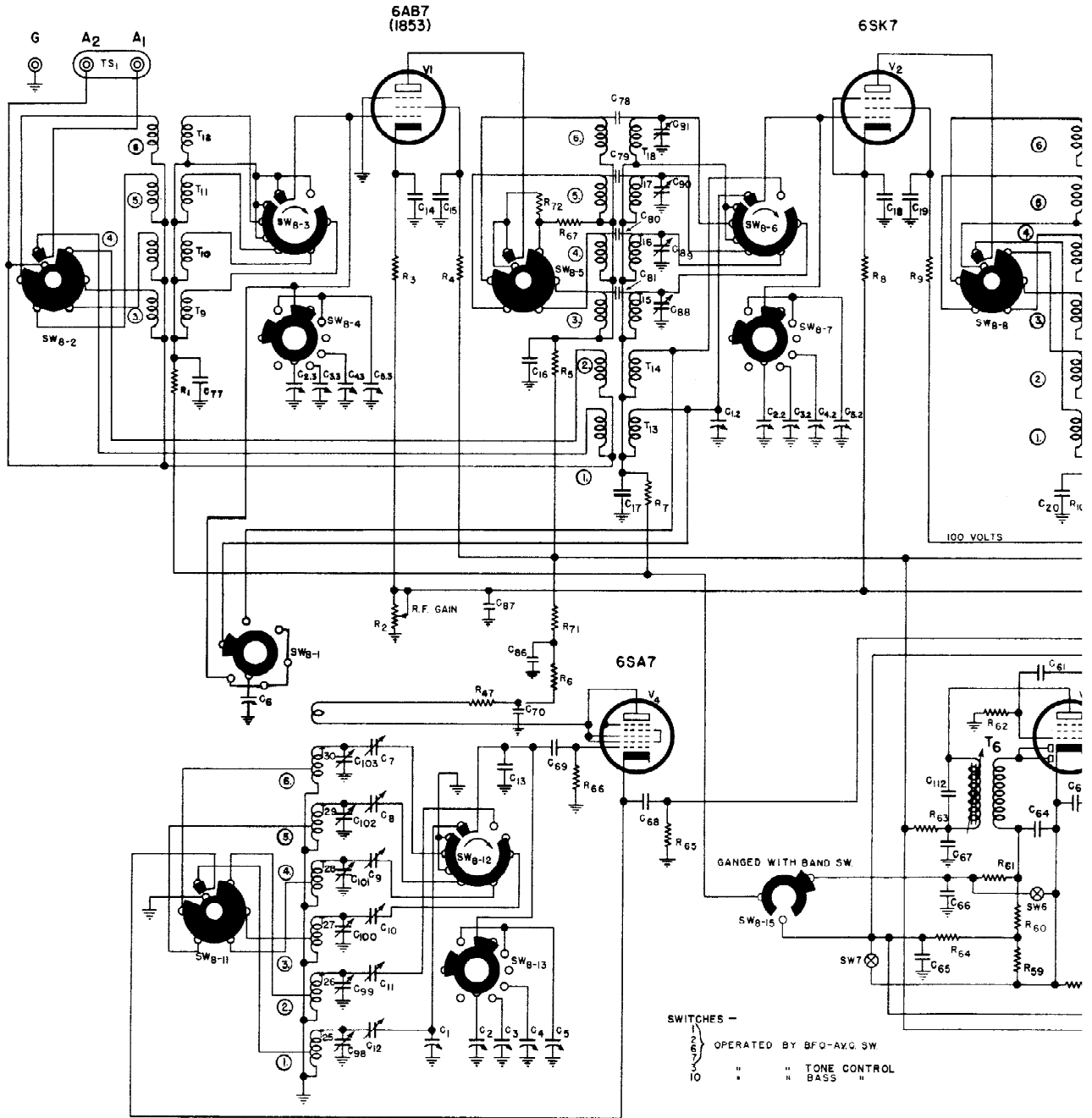

FREQUENCY RANGES.

1. 0.55MC. TO 1.6 MC.
2. 1.6 MC. TO 3.0MC
3. 3.0 MC. TO 5.8MC
4. 5.8 MC. TO 11.0MC
5. 11.0 MC. TO 21.0MC.
6. 21.0 MC. TO 43.0MC.

- AVG - BFO SWITCH
- LEFT CENTER RIGHT
- SW1 OPEN CLOSED CLOSED
- SW6 OPEN CLOSED CLOSED
- SW7 OPEN CLOSED CLOSED
- SW2 OPEN OPEN CLOSED

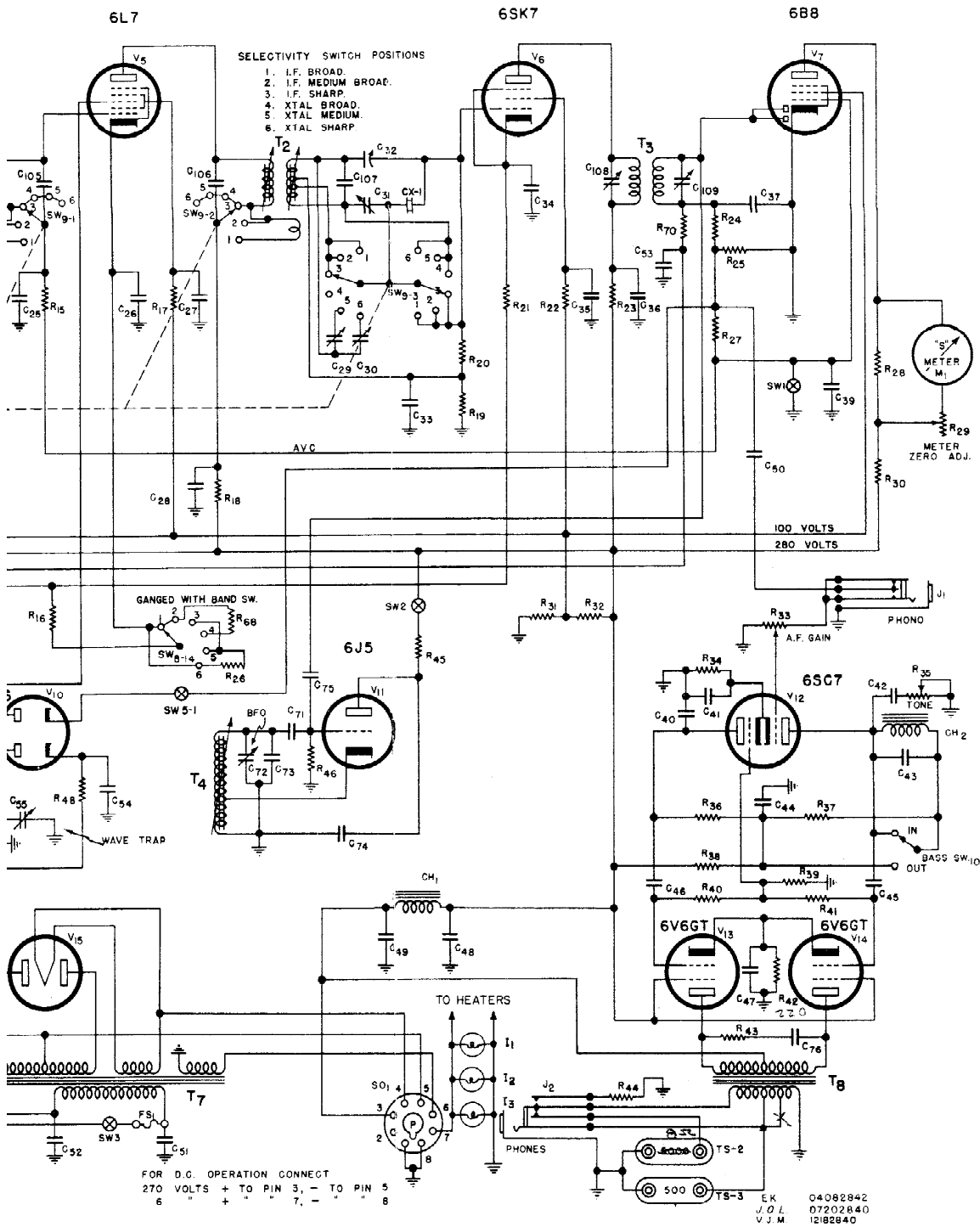

FIG. 13—SX28—SCHEMATIC